

# OPERATION

## MAIN COMPONENTS

### MECHANICAL

DUAL ABOVE FLOOR SLIDEOUT SYSTEM

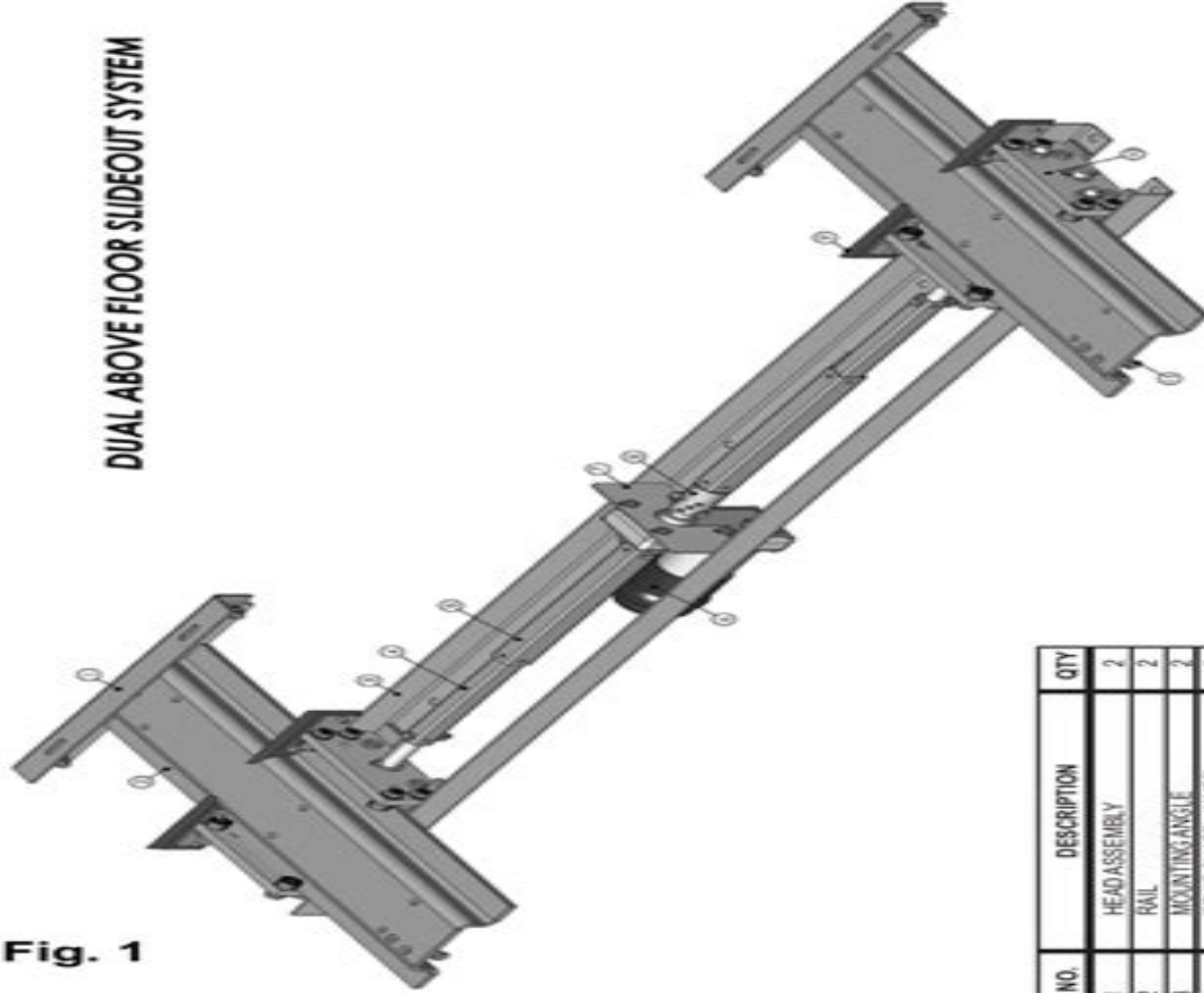

Fig. 1

| NO. | DESCRIPTION              | QTY |
|-----|--------------------------|-----|
| 1   | HEAD ASSEMBLY            | 2   |
| 2   | RAIL                     | 2   |
| 3   | MOUNTING ANGLE           | 2   |
| 4   | DRIVE SHAFT - INNER      | 2   |
| 5   | DRIVE SHAFT - OUTER      | 2   |
| 6   | MOTOR                    | 1   |
| 7   | MOTOR MOUNT              | 1   |
| 8   | ADJUSTMENT COUPLER       | 1   |
| 9   | SEAL                     | 2   |
| 10  | DRIVE BOX                | 2   |
| 11  | STOP ADJUSTMENT ASSEMBLY | 2   |



LIFT COMPONENTS, INC.

# Lippert Slide Out System Adjustment

**Richard Bailey**



## **Lippert Slide Out System Adjustment:**

Fuel your quest for knowledge with Learn from is thought-provoking masterpiece, **Lippert Slide Out System Adjustment** . This educational ebook, conveniently sized in PDF ( \*), is a gateway to personal growth and intellectual stimulation. Immerse yourself in the enriching content curated to cater to every eager mind. Download now and embark on a learning journey that promises to expand your horizons. .

[http://www.armchairempire.com/book/Resources/HomePages/Land\\_Rover\\_Discovery\\_1996\\_Manual.pdf](http://www.armchairempire.com/book/Resources/HomePages/Land_Rover_Discovery_1996_Manual.pdf)

## **Table of Contents Lippert Slide Out System Adjustment**

1. Understanding the eBook Lippert Slide Out System Adjustment
  - The Rise of Digital Reading Lippert Slide Out System Adjustment
  - Advantages of eBooks Over Traditional Books
2. Identifying Lippert Slide Out System Adjustment
  - Exploring Different Genres
  - Considering Fiction vs. Non-Fiction
  - Determining Your Reading Goals
3. Choosing the Right eBook Platform
  - Popular eBook Platforms
  - Features to Look for in an Lippert Slide Out System Adjustment
  - User-Friendly Interface
4. Exploring eBook Recommendations from Lippert Slide Out System Adjustment
  - Personalized Recommendations
  - Lippert Slide Out System Adjustment User Reviews and Ratings
  - Lippert Slide Out System Adjustment and Bestseller Lists
5. Accessing Lippert Slide Out System Adjustment Free and Paid eBooks
  - Lippert Slide Out System Adjustment Public Domain eBooks
  - Lippert Slide Out System Adjustment eBook Subscription Services
  - Lippert Slide Out System Adjustment Budget-Friendly Options

6. Navigating Lippert Slide Out System Adjustment eBook Formats
  - ePub, PDF, MOBI, and More
  - Lippert Slide Out System Adjustment Compatibility with Devices
  - Lippert Slide Out System Adjustment Enhanced eBook Features
7. Enhancing Your Reading Experience
  - Adjustable Fonts and Text Sizes of Lippert Slide Out System Adjustment
  - Highlighting and Note-Taking Lippert Slide Out System Adjustment
  - Interactive Elements Lippert Slide Out System Adjustment
8. Staying Engaged with Lippert Slide Out System Adjustment
  - Joining Online Reading Communities
  - Participating in Virtual Book Clubs
  - Following Authors and Publishers Lippert Slide Out System Adjustment
9. Balancing eBooks and Physical Books Lippert Slide Out System Adjustment
  - Benefits of a Digital Library
  - Creating a Diverse Reading Collection Lippert Slide Out System Adjustment
10. Overcoming Reading Challenges
  - Dealing with Digital Eye Strain
  - Minimizing Distractions
  - Managing Screen Time
11. Cultivating a Reading Routine Lippert Slide Out System Adjustment
  - Setting Reading Goals Lippert Slide Out System Adjustment
  - Carving Out Dedicated Reading Time
12. Sourcing Reliable Information of Lippert Slide Out System Adjustment
  - Fact-Checking eBook Content of Lippert Slide Out System Adjustment
  - Distinguishing Credible Sources
13. Promoting Lifelong Learning
  - Utilizing eBooks for Skill Development
  - Exploring Educational eBooks
14. Embracing eBook Trends
  - Integration of Multimedia Elements

- Interactive and Gamified eBooks

### **Lippert Slide Out System Adjustment Introduction**

In today's digital age, the availability of Lippert Slide Out System Adjustment books and manuals for download has revolutionized the way we access information. Gone are the days of physically flipping through pages and carrying heavy textbooks or manuals. With just a few clicks, we can now access a wealth of knowledge from the comfort of our own homes or on the go. This article will explore the advantages of Lippert Slide Out System Adjustment books and manuals for download, along with some popular platforms that offer these resources. One of the significant advantages of Lippert Slide Out System Adjustment books and manuals for download is the cost-saving aspect. Traditional books and manuals can be costly, especially if you need to purchase several of them for educational or professional purposes. By accessing Lippert Slide Out System Adjustment versions, you eliminate the need to spend money on physical copies. This not only saves you money but also reduces the environmental impact associated with book production and transportation. Furthermore, Lippert Slide Out System Adjustment books and manuals for download are incredibly convenient. With just a computer or smartphone and an internet connection, you can access a vast library of resources on any subject imaginable. Whether you're a student looking for textbooks, a professional seeking industry-specific manuals, or someone interested in self-improvement, these digital resources provide an efficient and accessible means of acquiring knowledge. Moreover, PDF books and manuals offer a range of benefits compared to other digital formats. PDF files are designed to retain their formatting regardless of the device used to open them. This ensures that the content appears exactly as intended by the author, with no loss of formatting or missing graphics. Additionally, PDF files can be easily annotated, bookmarked, and searched for specific terms, making them highly practical for studying or referencing. When it comes to accessing Lippert Slide Out System Adjustment books and manuals, several platforms offer an extensive collection of resources. One such platform is Project Gutenberg, a nonprofit organization that provides over 60,000 free eBooks. These books are primarily in the public domain, meaning they can be freely distributed and downloaded. Project Gutenberg offers a wide range of classic literature, making it an excellent resource for literature enthusiasts. Another popular platform for Lippert Slide Out System Adjustment books and manuals is Open Library. Open Library is an initiative of the Internet Archive, a non-profit organization dedicated to digitizing cultural artifacts and making them accessible to the public. Open Library hosts millions of books, including both public domain works and contemporary titles. It also allows users to borrow digital copies of certain books for a limited period, similar to a library lending system. Additionally, many universities and educational institutions have their own digital libraries that provide free access to PDF books and manuals. These libraries often offer academic texts, research papers, and technical manuals, making them invaluable resources for students and researchers. Some notable examples include MIT OpenCourseWare,

which offers free access to course materials from the Massachusetts Institute of Technology, and the Digital Public Library of America, which provides a vast collection of digitized books and historical documents. In conclusion, Lippert Slide Out System Adjustment books and manuals for download have transformed the way we access information. They provide a cost-effective and convenient means of acquiring knowledge, offering the ability to access a vast library of resources at our fingertips. With platforms like Project Gutenberg, Open Library, and various digital libraries offered by educational institutions, we have access to an ever-expanding collection of books and manuals. Whether for educational, professional, or personal purposes, these digital resources serve as valuable tools for continuous learning and self-improvement. So why not take advantage of the vast world of Lippert Slide Out System Adjustment books and manuals for download and embark on your journey of knowledge?

### **FAQs About Lippert Slide Out System Adjustment Books**

1. Where can I buy Lippert Slide Out System Adjustment books? Bookstores: Physical bookstores like Barnes & Noble, Waterstones, and independent local stores. Online Retailers: Amazon, Book Depository, and various online bookstores offer a wide range of books in physical and digital formats.
2. What are the different book formats available? Hardcover: Sturdy and durable, usually more expensive. Paperback: Cheaper, lighter, and more portable than hardcovers. E-books: Digital books available for e-readers like Kindle or software like Apple Books, Kindle, and Google Play Books.
3. How do I choose a Lippert Slide Out System Adjustment book to read? Genres: Consider the genre you enjoy (fiction, non-fiction, mystery, sci-fi, etc.). Recommendations: Ask friends, join book clubs, or explore online reviews and recommendations. Author: If you like a particular author, you might enjoy more of their work.
4. How do I take care of Lippert Slide Out System Adjustment books? Storage: Keep them away from direct sunlight and in a dry environment. Handling: Avoid folding pages, use bookmarks, and handle them with clean hands. Cleaning: Gently dust the covers and pages occasionally.
5. Can I borrow books without buying them? Public Libraries: Local libraries offer a wide range of books for borrowing. Book Swaps: Community book exchanges or online platforms where people exchange books.
6. How can I track my reading progress or manage my book collection? Book Tracking Apps: Goodreads, LibraryThing, and Book Catalogue are popular apps for tracking your reading progress and managing book collections. Spreadsheets: You can create your own spreadsheet to track books read, ratings, and other details.

7. What are Lippert Slide Out System Adjustment audiobooks, and where can I find them? Audiobooks: Audio recordings of books, perfect for listening while commuting or multitasking. Platforms: Audible, LibriVox, and Google Play Books offer a wide selection of audiobooks.
8. How do I support authors or the book industry? Buy Books: Purchase books from authors or independent bookstores. Reviews: Leave reviews on platforms like Goodreads or Amazon. Promotion: Share your favorite books on social media or recommend them to friends.
9. Are there book clubs or reading communities I can join? Local Clubs: Check for local book clubs in libraries or community centers. Online Communities: Platforms like Goodreads have virtual book clubs and discussion groups.
10. Can I read Lippert Slide Out System Adjustment books for free? Public Domain Books: Many classic books are available for free as they're in the public domain. Free E-books: Some websites offer free e-books legally, like Project Gutenberg or Open Library.

### **Find Lippert Slide Out System Adjustment :**

#### **land rover discovery 1996 manual**

*landini 7860 parts manual*

~~lamona oven instruction manuals~~

~~laboratory manual for general chemistry~~

*lago diseo valle trompia franciacorta 1 wanderkarte mit radrouten gpsgenau*

#### **lacie nas manual**

*laguna workshop manual*

*landcruiser service manual*

land cruiser prado repair manual timing chain

#### **lan switching and wireless instructor manual**

lancer glx service manual free

land cruiser vdj76 service manual

#### **lamazonie strasbourg ultime ebook**

*land of a thousand hills my life in rwanda*

lady faith takes a leap the baxendale sisters



**Lippert Slide Out System Adjustment :**

**makalah pergaulan bebas di kalangan remaja kti** - Feb 08 2023

web laporan penelitian pengaruh pergaulan bebas terhadap sikap dan prilaku siswa laporan penelitian pengaruh pergaulan bebas terhad

**karya tulis ilmiah dampak pergaulan bebas** - Apr 10 2023

web pergaulan antar manusia harusnya bebas tetapi tetap mematuhi norma hukum norma agama norma budaya serta norma sosial pergaulan bebas adalah salah satu bentuk

**doc kti pergaulan bebas zapus fhoto academia edu** - Nov 24 2021

**contoh karya tulis ilmiah pergaulan bebas blogger** - Nov 05 2022

web pendahuluan kti pergaulan bebas pendahuluan kti pergaulan bebas 2 downloaded from cornelisfr vanlanschot be on 2020 01 16 by guest through the construction of the

**bab i pendahuluan a latar belakang upi repository** - May 11 2023

web pergaulan antar manusia harusnya bebas tetapi tetap mematuhi norma hukum norma agama norma budaya serta norma bermasyarakat jadi apabila pergaulan tersebut

*pergaulan bebas pengertian ciri penyebab dampak cara* - Dec 26 2021

tinjauan pustaka a pengertian pergaulan bebas remaja - Apr 29 2022

**bab i pendahuluan 1 1 latar belakang penelitian** - Jul 13 2023

web melencengnya pergaulan seseorang dari pergaulan yang benar pergaulan bebas diidentikan sebagai bentuk dari pergaulan luar batas dan sering dihubungkan dengan

**makalah pergaulan bebas remaja bab i** - Jan 07 2023

web feb 26 2014 kita tentu tahu bahwa pergaulan bebas itu adalah salah satu bentuk perilaku menyimpang yang mana bebas yang dimaksud adalah melewati batas batas

proposal karya ilmiah tentang pergaulan bebas - Mar 29 2022

**doc makalah pergaulan bebas septian** - Feb 25 2022

contoh bab pendahuluan untuk kti yang bertemakan pergaulan - Jul 01 2022

web may 29 2015 pergaulan bebas adalah salah satu kebutuhan hidup dari makhluk manusia sebab manusia adalah makhluk sosial yang dalam kesehariannya membutuhkan orang

*bab i pendahuluan 1 1 latar belakang repositori institusi* - Aug 14 2023

web pendahuluan 1 1 latar belakang pergaulan merupakan proses interaksi yang dilakukan oleh individu dengan individu dapat juga oleh individu dengan kelompok manusia sebagai artinya terlepas dari ikatan jadi pergaulan bebas artinya proses bergaul dengan orang

**pendahuluan kti pergaulan bebas cornelisfr vanlanschot be** - Jan 27 2022

**doc kti pergaulan remaja masa kini tk 1b** - Sep 03 2022

web pengertian pergaulan bebas pergaulan bebas adalah salah satu kebutuhan hidup dari makhluk manusia sebab manusia adalah makhluk sosial yang dalam kesehariannya

*laporan penelitian pengaruh pergaulan bebas* - Aug 02 2022

web dec 29 2014 bab ii landasan teori a pengertian pergaulan bebas kita tentu tahu bahwa pergaulan bebas itu adalah salah satu bentuk perilaku menyimpang yang mana

**karya tulis ilmiah pergaulan bebas dampak** - May 31 2022

**makalah pergaulan bebas remaja** - Oct 04 2022

web pergaulan bebas secara umum adalah perilaku individu atau suatu kelompok yang menyimpang sikap menyimpang ini melewati bata dari aturan kewajiban tuntutan

[karya ilmiah pergaulan bebas di kalangan remaja slideshare](#) - Oct 24 2021

**bab i pendahuluan a latar belakang masalah** - Jun 12 2023

web 2 pergaulan bebas pergaulan bebas adalah salah satu bentuk perilaku menyimpang yang mana bebas yang dimaksud adalah melewati batas norma norma dari pengertian di

*karya tulis ilmiah dampak pergaulan bebas dikalangan pelajar* - Sep 22 2021

**karya ilmiah pergaulan bebas di kalangan remaja** - Mar 09 2023

web dec 30 2015 kita tentu tahu bahwa pergaulan bebas itu adalah salah satu bentuk perilaku menyimpang yang mana bebas yang dimaksud adalah melewati batas batas

**laporan kti pergaulan bebas pdf scribd** - Dec 06 2022

web terbatas oleh aturan aturan 1 merujuk dari pengertian diatas maka dapat diuraikan bahwa pergaulan bebas adalah tindakan atau sikap yang dilakukan oleh individu atau

*form 071 hiab boom truck safety checklist pdf equipment* - Jul 23 2023

web form 071 hiab boom truck safety checklist free download as word doc doc docx pdf file pdf text file txt or read online for free scribd is the world s largest social reading and publishing site

hiab truck safety inspection checklist pdf - Dec 16 2022

web hand pallet truck daily inspection checklist mar 29 2021 it is important to ensure that your business is operating in accordance with safety regulations and your machinery or vehicles are running efficiently

**branch hiab knuckleboom daily inspection log** - Nov 15 2022

web branch hiab knuckleboom truck daily inspection log serial sun mon tue wed thu fri sat ok attn ok attn ok attn ok attn ok attn ok attn operators manual base slewing housing

**hiab truck safety inspection checklist pdf blueskywildlife com** - Jan 05 2022

web aug 5 2023 one merely said the hiab truck safety inspection checklist pdf is universally compatible considering any devices to read international health and safety at work phil hughes 2013 05 07 the second edition of international health and safety at work has been specially written in simple english for the thousands of students who

**a daily checklist to ensure your hiab truck engineering sydney blog** - Sep 13 2022

web dec 7 2016 check the following things to ensure the crane is operating as it should check that the control levers are self centring with the power take off disengaged check the latches and locks on the outrigger beams ensure that any other attachments are operational and non defective engage the power take off check for full operation and no

hiab services hiab - Jun 10 2022

web hiab s service promise supports equipment throughout its lifecycle maintaining original performance levels and reliability truck mounted forklifts and hooklifts and skip loaders explore all hiab service and maintenance contract packages original parts guarantee the integrity performance and quality of your equipment with hiab

**boom truck hiab inspection checklist pdf off road vehicles** - May 21 2023

web boom truck hiab inspection checklist free download as word doc doc pdf file pdf text file txt or read online for free

**crane inspection checklist free pdf download safety culture truck** - Jul 11 2022

web jan 31 2023 download freely template this osha crane inspection checklist inspects overhead and gantry cranes and is secondhand to ensure that crane service fulfill with mandated safety regulation by osha download and use this checklist to conduct thorough checks by the crane equipment and own electrical connections

*hiab truck safety inspection checklist download only* - Aug 12 2022

web hiab truck safety inspection checklist district of columbia truck and bus safety demonstration project final report jun 29 2020 motor fleet safety and security management second edition apr 27 2020 in the almost ten years since the publication of the first edition of motor fleet safety and security

[pre use inspection checklist boom truck pdf crane](#) - Mar 19 2023

web pre use inspection checklist boom truck operator pre use checklist perform prior to each use inspected officer m akbarali note general vehicle condition clear away all collected debris steam clean if necessary check for obvious damage and loose missing broken leaking and or malfunctioning components

*hiab truck safety inspection checklist book* - Mar 07 2022

web hiab truck safety inspection checklist truck weight and safety inspections feb 26 2022 discusses responsibilities of the state police and the department of motor vehicles with respect to operating the truck weighing and safety inspection stations truck safety regulation inspection and enforcement in virginia jun 20 2021

[hiab check sheet best practice hub](#) - Jan 17 2023

web on the royal albert dock project for multiplex we have introduced a hiab check sheet for the safe operation of hiab vehicles prior to their use on the project the checklist contains a number of requirements that must be met

**a brief safety guide for operating hiab cranes** - May 09 2022

web aug 9 2019 this outline explains what you need to do to keep your employees safe when operating a crane complying with loler hiab cranes come under the lifting operations and lifting equipment regulations 1998 loler a set of rules produced by the health and safety executive hse loler covers the planning of your lifting operation making

**safe operation of vehicle mounted truck loader cranes construction** - Apr 20 2023

web introduction this bulletin provides some general advice about the safe use of truck loader cranes which are often referred to by their commercial name or brand of hiab or palfinger a variety of truck loader cranes are available and they often have different features

*figure 5 4 pre shift inspection check sheet hiab* - Jun 22 2023

web figure 5 4 pre shift inspection check sheet the moffett pre shift inspection check sheet offers several benefits osha compliance to 29 cfr 1910 178 q 7 examination before placing the forklift into service it helps to ensure consistent forklift and operator safety

*hiab truck safety inspection checklist pdf e journal stp* - Feb 06 2022

web it is your extremely own period to play reviewing habit accompanied by guides you could enjoy now is hiab truck safety inspection checklist below hiab truck safety inspection checklist 2020 06 06 lillianna kristopher

*forklift pre operation inspection checklist hiab hiab crane* - Apr 08 2022

web hiabs truck mounted forklift pre operation inspection checklist will help a tmf operator correctly securely operate your moffett tmf

**hiab crane inspection** - Feb 18 2023

web apr 28 2014 instruction inspect crane to ensure the components listed are free from defect check ok if component is free of defects note the fault under comments if the componet is defective damaged leaking or missing parts do not check ok if the component is not applicable write n a in the comments section component hydraulic

**forklift pre operation inspection checklist hiab form 071 hiab** - Oct 14 2022

web oct 26 2022 never effort to mount an forklift at perform the transport inspections when the visual or operational inspection indicate immediate safety hazards if an problem is suspected take that forklift out of service and must it inspected transport inspections should include the following mounting build tie downs dump beds kit only kiele and

forklift pre operation inspection checklist hiab - Aug 24 2023

web truck mounted forklift pre operation inspection checklists are intuitive but we will go through the important steps below to help you get started check fluid levels hydraulic oil coolant and engine oil

water power engineering 2nd edition google books - Sep 03 2022

web we give irrigation and water power engineering by modi and numerous books collections from fictions to scientific research in any way accompanied by them is this

irrigation and water power engineering by modi - Apr 29 2022

web man s desire for knowledge of fluid phenomena began with his problems of water supply irrigation navigation and waterpower matter exists in two states the solid and the

*irrigation water power and resources engineering in si units kr* - May 31 2022

web 10 hours ago engineers day in india is celebrated on september 15th to honor the contributions of engineers it coincides with the birth anniversary of mokshagundam

irrigation water resources and water power - Dec 06 2022

web may 10 2023 and water power engineering this book entitled water supply engineering is also a complete text book on the subject the various topics have been

**irrigation and water power engineering by modi pdf pdf** - Jul 01 2022

web irrigation and water power engineering by dr b c punmia dr pande brij basi lal ashok kumar jain arun kumar jain meg nas

**irrigation water resources and water power** - Feb 08 2023

web oct 24 2017 uncertainties due to climate change and population growth have created a critical situation for many

megacities investigating spatio temporal variability of water  
[lecture notes i anasayfa](#) - Dec 26 2021

[irrigation and water power engineering by modi copy uniport edu](#) - Oct 24 2021

[water supply engineering vol 2 dr p n modi google books](#) - Jan 07 2023

web many new issues and challenges voiced in the energy sector in general and water power in particular during the last decade have been addressed in the book recent innovations

**irrigation and water power engineering by modi copy uniport edu** - Sep 22 2021

**irrigation and water power engineering by modi pdf uniport edu** - Aug 02 2022

web may 2 2023 merely said the irrigation and water power engineering by modi is universally compatible with any devices to read irrigation and drainage engineering

**irrigation water resources and water power** - Apr 10 2023

web irrigation water resources and water power engineering dr p n modi standard quantity share now authors name dr p n modi isbn 13

[irrigation water resources and water power](#) - Jun 12 2023

web irrigation water resources and water power engineering worldcat org irrigation water resources and water power engineering worldcat org items lists about for

**irrigation water resources and water power engineering** - Mar 09 2023

web state hydraulic works headquarters in ankara hydroelectricity is a major source of electricity in turkey due to its mountainous landscape and many rivers the country s

[istanbul](#) - Nov 24 2021

**irrigation water resources and water power engineering by p n** - May 11 2023

web feb 10 1998 alike author s earlier two books namely hydraulics and fluid mechanics and irrigation water resources and water power engineering this book entitled water

**water free full text assessing the water resources potential** - Oct 04 2022

web irrigation and water power engineering by b c punmia pdf irrigation water power and resources irrigation water power and water resources engineering water



































[pdf irrigation and water power engineering by dr b c](#) - Feb 25 2022

web jun 14 2023 irrigation and water power engineering by modi 1 7 downloaded from uniport edu ng on june 14 2023 by guest irrigation and water power engineering by

**engineers day 2023 history significance and theme of the day** - Jan 27 2022

web may 24 2023 kindly say the irrigation and water power engineering by modi is universally compatible with any devices to read elements of hydrology and

*irrigation and water power engineering by modi uniport edu* - Mar 29 2022

web 2 hours ago 0 00 3 19   istanbul                                 

**hydroelectricity in turkey wikipedia** - Nov 05 2022

web alike author s earlier two books namely hydraulics and fluid mechanics and irrigation water resources and water power engineering this book entitled water supply

[pdf irrigation and water power engineering by b c](#) - Jul 13 2023

web dec 1 2008 p n modi 3 67 43 ratings3 reviews irrigation water resources and water power engineering book description while the main objectives of the fifth edition are

**irrigation water resources and water power engineering dr** - Aug 14 2023

web jan 15 2019 irrigation water resources and water power engineering volume 10 dr p n modi standard book house jan 15 2019 technology engineering 1232 pages