

# Weld Joint and its Types

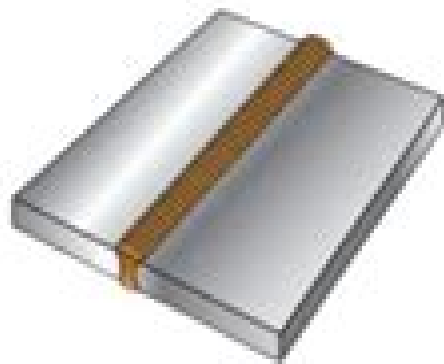

Butt joint



Edge joint

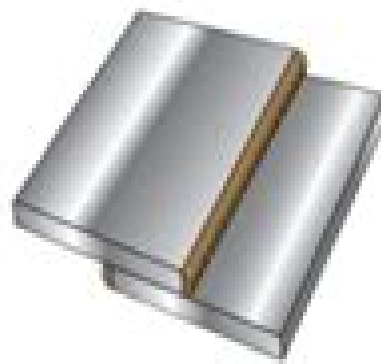

Lap joint



Tee joint



Corner joint

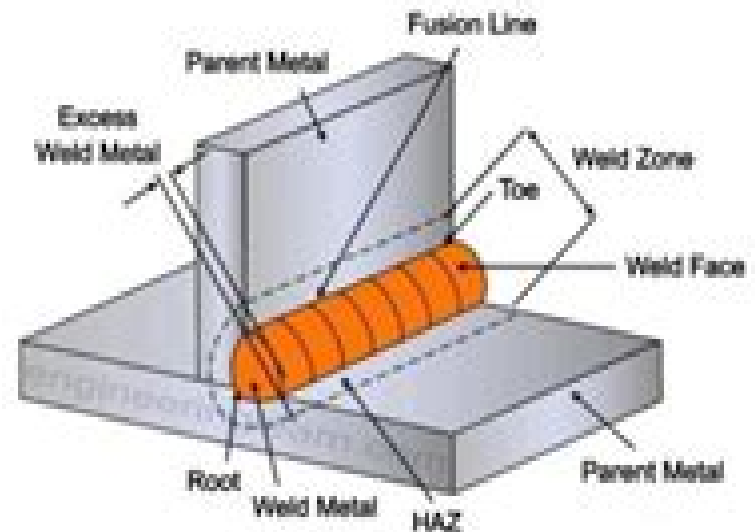
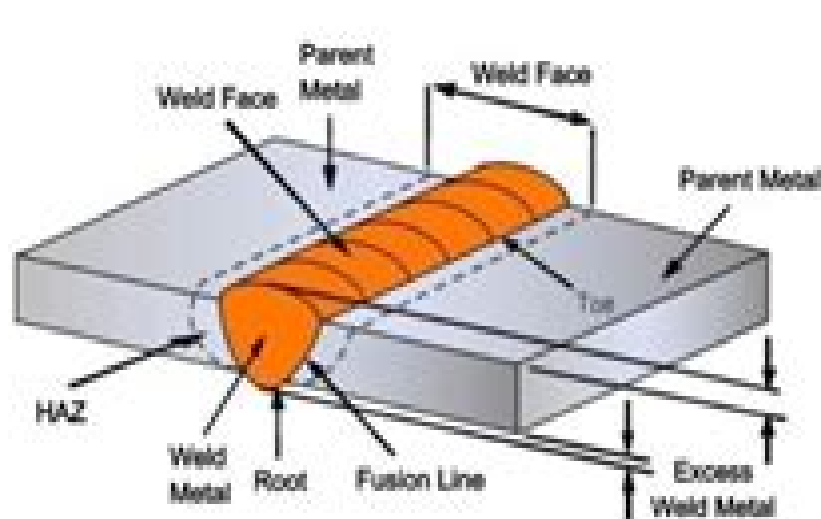

# Guide For Types Of Welds

**J Hicks**



## **Guide For Types Of Welds:**

**PPI PE Civil Study Guide, 17th Edition** Michael R. Lindeburg, 2022-09-30 Maximize your efficiency while studying for the PE Civil CBT exam by pairing the PE Civil Study Guide with Michael R Lindeburg s PE Civil Reference Manual PE Civil Study Guide Seventeenth Edition provides a strategic and targeted approach to exam preparation so that you gain a competitive edge With hundreds of entries containing helpful explanations derivations of equations and exam tips the Study Guide connects the NCEES exam specifications for all five PE Civil exams to the NCEES Handbook approved design standards and PPI s civil reference manuals The Study Guide is organized to make the most of your time and is an essential tool for a successful exam experience Relevant sections from the NCEES Handbook design standards and PPI s reference manuals are clearly indicated in both summary lists for each exam specification and in each of the detailed entries covering a specific concept or equation Referenced PPI Products PE Civil Reference Manual Structural Depth Reference Manual for the PE Civil Exam Construction Depth Reference Manual for the PE Civil Exam Transportation Depth Reference Manual for the PE Civil Exam Water Resources and Environmental Depth Reference Manual for the PE Civil Exam Referenced Codes and Standards 2015 International Building Code ICC A Policy on Geometric Design of Highways Streets AASHTO AASHTO Guide for Design of Pavement Structures AASHTO AASHTO LRFD Bridge Design Specifications Building Code Requirements Specification for Masonry Structures ACI 530 Building Code Requirements for Structural Concrete Commentary ACI 318 Design Construction of Driven Pile Foundations FHWA Design Construction of Driven Pile Foundations Volume I FHWA Design Control of Concrete Mixtures PCA Design Loads on Structures During Construction ASCE 37 Formwork for Concrete ACI SP 4 Foundations Earth Structures Design Manual 7 02 Geotechnical Aspects of Pavements FHWA Guide for the Planning Design Operation of Pedestrian Facilities AASHTO Guide to Design of Slabs on Ground ACI 360R Guide to Formwork for Concrete ACI 347R Highway Capacity Manual TRB Highway Safety Manual AASHTO Hydraulic Design of Highway Culverts FHWA LRFD Seismic Analysis Design of Transportation Geotechnical Features Structural Foundations Reference Manual FHWA Manual on Uniform Traffic Control Devices FHWA Minimum Design Loads for Buildings Other Structures ASCE SEI 7 National Design Specification for Wood Construction AWC Occupational Safety Health Regulations for the Construction Industry OSHA 1926 Occupational Safety Health Standards OSHA 1910 PCI Design Handbook Precast Prestressed Concrete PCI Recommended Standards for Wastewater Facilities TSS Roadside Design Guide AASHTO Soils Foundations Reference Manual Volume I II FHWA Steel Construction Manual AISC Structural Welding Code Steel AWS

**Roofing and Cladding Systems Handbook** Reid, 2000-01-31 1 Weather Effects on Roofing Systems 2 Understanding Your Roofing and Cladding Systems 3 Building Envelope Roofing Structure 4 Roofing Construction Materials 5 Insulation Waterproofing Membranes 6 Energy System Calculations 7 Fasteners Flashings Holding the Roof on the Roof 8 Penetrations Through the Roofing System 9 Roofing Project Management 10 Convention and Unconventional Roofing Structures 11

Warranty and Maintenance of Roofing Systems<sup>12</sup> Roofing People<sup>13</sup> Roofing Safety Liability<sup>14</sup> Industry Trade Associations  
Glossary of Roofing Terminology  
Bibliography  
Index

*A Guide to Designing Welds* J Hicks, 1989 A practical how to do it book written with the design and welding interface in mind It informs designers not only of what they should know about welding but also and most importantly sets out the information the designer should give to the welding engineer or fabrication superintendent so that the designer's aims can be achieved in terms of engineering performance safety reliability cost and appearance

, Welder's Handbook Richard Finch, 2007-02-21 A newly updated state of the art guide to MIG and TIG arc welding technology Written by a noted authority in the field this revised edition of HP's bestselling automotive book for over 20 years is a detailed instructional manual on the theory technique equipment and proper procedures of metal inert gas MIG and tungsten inert gas TIG welding

**Facilities Drafting Manual** United States. Office of Manned Space Flight, 1964

**The 1984 Guide to the Evaluation of Educational Experiences in the Armed Services**, 1984

**The McGraw-Hill Civil Engineering PE Exam Depth Guide** M. Myint Lwin, Chyuan-Shen Lee, J. J. Lee, 2001 Designed to complement the McGraw Hill Civil Engineering PE Exam Guide Breadth and Depth this subject specific depth guide provides comprehensive coverage of the subject matter applicants will face in the afternoon portion of the PE exam Each book authored by an expert in the field will feature example problems from previous exams along with power study techniques for peak performance

**The 1980 Guide to the Evaluation of Educational Experiences in the Armed Services: Coast Guard, Marine Corps, Navy, Dept. of Defense** American Council on Education, 1980

**Manual of Engineering Drawing** Colin H. Simmons, Dennis E. Maguire, Neil Phelps, 2020-03-28 Manual of Engineering Drawing British and International Standards Fifth Edition chronicles ISO and British Standards in engineering drawings providing many examples that will help readers understand how to translate engineering specifications into a visual medium The book includes 6 introductory chapters which provide foundational theory and contextual information regarding the broader context of engineering drawing and design The concepts enclosed will help readers gain the most out of their drawing skills As the standards referred to in this book change every few years this new edition presents an important update Covers all of the BSI and ISO standards that govern the drafting of technical product specification and standards Includes new chapters on design for additive manufacturing and computer aided design Provides worked examples that will help readers understand how the concepts in the book are applied in practice

**Welding: A Comprehensive Guide** Pasquale De Marco, 2025-07-23 Welding A Comprehensive Guide is the definitive reference book for welders of all levels Written by a team of expert welders this book covers everything you need to know about welding from the basics to the most advanced techniques Whether you're a beginner or a seasoned pro you'll find valuable information in this book The book starts with an overview of the welding process including the different types of welding the equipment you'll need and the safety precautions you should take From there the book dives into the details of each welding process including step by step instructions on how to perform each weld

The book also covers the metallurgy of welding which is essential for understanding how welds work and how to make them strong and durable The book also includes a chapter on welding codes and standards so you can be sure that your welds meet the requirements of your industry In addition to the technical information the book also includes a wealth of practical advice on how to troubleshoot welding problems and how to improve your welding skills With its clear explanations detailed illustrations and expert advice *Welding A Comprehensive Guide* is the only book you ll need to become a master welder Here are just a few of the things you ll learn in this book The different types of welding processes The equipment you need for each welding process The safety precautions you should take when welding How to perform each type of weld The metallurgy of welding Welding codes and standards How to troubleshoot welding problems How to improve your welding skills With *Welding A Comprehensive Guide* you ll have the knowledge and skills you need to weld like a pro If you like this book write a review

**Technical Guide for Gas Tungsten Arc Welding** Martha A. Baker,1994 *Technical Manual* United States Department of the Army,1966

**Operator's and Organizational Maintenance Manual** ,1987 **Guide Design Specification for Bridge Temporary Works** American Association of State Highway and Transportation Officials,1995

**Manual of Engineering Drawing** Colin Simmons,Colin H. Simmons,Dennis E. Maguire,Neil Phelps,2012-06-29 Now in its 4th edition *Manual of Engineering Drawing* is a long established guide for practicing and student engineers to producing engineering drawings and annotated 3D models that comply with the latest BSI and ISO standards of technical product specifications and documentation This new edition has been updated in line with recent standard revisions and amendments including the requirements of BS8888 2011 and related ISO standards Ideal for international use it includes a guide to the fundamental differences between the relevant ISO and ASME standards as well as new information on leg

**Pipeline Rules of Thumb Handbook** E.W. McAllister,2015-06-02 This classic reference has built a reputation as the go to book to solve even the most vexing pipeline problems Now in its seventh edition *Pipeline Rules of Thumb Handbook* continues to set the standard by which all others are judged The 7th edition features over 30% new and updated sections reflecting the exponential changes in the codes construction and equipment since the sixth edition The seventh edition includes recommended drill sizes for self tapping screws new ASTM standard reinforcing bars calculations for calculating grounding resistance national Electrical Code tables Coriolis meters pump seals progressive cavity pumps and accumulators for lubricating systems Shortcuts for pipeline construction design and engineering Calculations methods and handy formulas Turnkey solutions to the most vexing pipeline problems *Handbook of Oil and Gas Piping* Murali Sambasivan,Sekar Gopal,2018-09-20 The objective of this practical oil and gas piping handbook is to facilitate project management teams of oil and gas piping related construction projects to understand the key requirements of the discipline and to equip them with the necessary knowledge and protocol It provides a comprehensive coverage on all the practical aspects of piping related material sourcing fabrication essentials welding related items NDT activities erection of pipes pre

commissioning post commissioning project management and importance of ISO Management systems in oil and gas piping projects This handbook assists contractors in ensuring the right understanding and application of protocols in the project One of the key assets of this handbook is that the technical information and the format provided are practically from real time oil and gas piping projects hence the application of this information is expected to enhance the credibility of the contractors in the eyes of the clients and to some extent simplify the existing operations Another important highlight is that it holistically covers the stages from the raw material to project completion to handover and beyond This will help the oil and gas piping contractors to train their project management staff to follow the best practices in the oil and gas industry Furthermore this piping handbook provides an important indication of the important project related factors hard factors and organizational related factors soft factors to achieve the desired project performance dimensions such as timely completion cost control acceptable quality safe execution and financial performance Lastly the role of ISO management systems such as ISO 9001 ISO 14001 and OHSAS 18001 in construction projects is widely known across the industry however oil and gas specific ISO quality management systems such as ISO 29001 and project specific management systems such as ISO 21500 are not widely known in the industry which are explained in detail in this handbook for the benefit of the oil and gas construction organizations Features Covering the stages from the raw material to project completion to handover and beyond Providing practical guidelines to oil and gas piping contractors for training purposes and best practices in the oil and gas industry Emphasizing project related factors hard factors and organizational related factors soft factors with a view to achieve the desired project performance Highlighting the roles of ISO management systems in oil and gas projects

Handbook of Plastics Joining Michael J. Troughton, 2008-10-17 The new edition of this bestselling reference provides fully updated and detailed descriptions of plastics joining processes plus an extensive compilation of data on joining specific materials The volume is divided into two main parts processes and materials The processing section has 18 chapters each explaining a different joining technique The materials section has joining information for 25 generic polymer families Both sections contain data organized according to the joining methods used for that material A significant and extensive update from experts at The Welding Institute A systematic approach to discussing each joining method including process advantages and disadvantages applications materials equipment joint design and welding parameters Includes international suppliers directory and glossary of key joining terms Includes new techniques such as flash free welding and friction stir welding Covers thermoplastics thermosets elastomers and rubbers

**Handbook of Engineering Practice of Materials and Corrosion** Jung-Chul (Thomas) Eun, 2020-09-04 This handbook is an in depth guide to the practical aspects of materials and corrosion engineering in the energy and chemical industries The book covers materials corrosion welding heat treatment coating test and inspection and mechanical design and integrity A central focus is placed on industrial requirements including codes standards regulations and specifications that practicing material and corrosion engineers and technicians

face in all roles and in all areas of responsibility The comprehensive resource provides expert guidance on general corrosion mechanisms and recommends materials for the control and prevention of corrosion damage and offers readers industry tested best practices rationales and case studies

Right here, we have countless books **Guide For Types Of Welds** and collections to check out. We additionally have enough money variant types and plus type of the books to browse. The conventional book, fiction, history, novel, scientific research, as well as various extra sorts of books are readily handy here.

As this Guide For Types Of Welds, it ends occurring monster one of the favored book Guide For Types Of Welds collections that we have. This is why you remain in the best website to see the amazing book to have.

<http://www.armchairempire.com/data/browse/index.jsp/honda%20cbr929rr%202000%202001%20repair%20service%20manual.pdf>

## **Table of Contents Guide For Types Of Welds**

1. Understanding the eBook Guide For Types Of Welds
  - The Rise of Digital Reading Guide For Types Of Welds
  - Advantages of eBooks Over Traditional Books
2. Identifying Guide For Types Of Welds
  - Exploring Different Genres
  - Considering Fiction vs. Non-Fiction
  - Determining Your Reading Goals
3. Choosing the Right eBook Platform
  - Popular eBook Platforms
  - Features to Look for in an Guide For Types Of Welds
  - User-Friendly Interface
4. Exploring eBook Recommendations from Guide For Types Of Welds
  - Personalized Recommendations
  - Guide For Types Of Welds User Reviews and Ratings
  - Guide For Types Of Welds and Bestseller Lists
5. Accessing Guide For Types Of Welds Free and Paid eBooks



- Guide For Types Of Welds Public Domain eBooks
  - Guide For Types Of Welds eBook Subscription Services
  - Guide For Types Of Welds Budget-Friendly Options
6. Navigating Guide For Types Of Welds eBook Formats
    - ePub, PDF, MOBI, and More
    - Guide For Types Of Welds Compatibility with Devices
    - Guide For Types Of Welds Enhanced eBook Features
  7. Enhancing Your Reading Experience
    - Adjustable Fonts and Text Sizes of Guide For Types Of Welds
    - Highlighting and Note-Taking Guide For Types Of Welds
    - Interactive Elements Guide For Types Of Welds
  8. Staying Engaged with Guide For Types Of Welds
    - Joining Online Reading Communities
    - Participating in Virtual Book Clubs
    - Following Authors and Publishers Guide For Types Of Welds
  9. Balancing eBooks and Physical Books Guide For Types Of Welds
    - Benefits of a Digital Library
    - Creating a Diverse Reading Collection Guide For Types Of Welds
  10. Overcoming Reading Challenges
    - Dealing with Digital Eye Strain
    - Minimizing Distractions
    - Managing Screen Time
  11. Cultivating a Reading Routine Guide For Types Of Welds
    - Setting Reading Goals Guide For Types Of Welds
    - Carving Out Dedicated Reading Time
  12. Sourcing Reliable Information of Guide For Types Of Welds
    - Fact-Checking eBook Content of Guide For Types Of Welds
    - Distinguishing Credible Sources
  13. Promoting Lifelong Learning
    - Utilizing eBooks for Skill Development

- Exploring Educational eBooks
14. Embracing eBook Trends
- Integration of Multimedia Elements
  - Interactive and Gamified eBooks

### **Guide For Types Of Welds Introduction**

In this digital age, the convenience of accessing information at our fingertips has become a necessity. Whether its research papers, eBooks, or user manuals, PDF files have become the preferred format for sharing and reading documents. However, the cost associated with purchasing PDF files can sometimes be a barrier for many individuals and organizations. Thankfully, there are numerous websites and platforms that allow users to download free PDF files legally. In this article, we will explore some of the best platforms to download free PDFs. One of the most popular platforms to download free PDF files is Project Gutenberg. This online library offers over 60,000 free eBooks that are in the public domain. From classic literature to historical documents, Project Gutenberg provides a wide range of PDF files that can be downloaded and enjoyed on various devices. The website is user-friendly and allows users to search for specific titles or browse through different categories. Another reliable platform for downloading Guide For Types Of Welds free PDF files is Open Library. With its vast collection of over 1 million eBooks, Open Library has something for every reader. The website offers a seamless experience by providing options to borrow or download PDF files. Users simply need to create a free account to access this treasure trove of knowledge. Open Library also allows users to contribute by uploading and sharing their own PDF files, making it a collaborative platform for book enthusiasts. For those interested in academic resources, there are websites dedicated to providing free PDFs of research papers and scientific articles. One such website is Academia.edu, which allows researchers and scholars to share their work with a global audience. Users can download PDF files of research papers, theses, and dissertations covering a wide range of subjects. Academia.edu also provides a platform for discussions and networking within the academic community. When it comes to downloading Guide For Types Of Welds free PDF files of magazines, brochures, and catalogs, Issuu is a popular choice. This digital publishing platform hosts a vast collection of publications from around the world. Users can search for specific titles or explore various categories and genres. Issuu offers a seamless reading experience with its user-friendly interface and allows users to download PDF files for offline reading. Apart from dedicated platforms, search engines also play a crucial role in finding free PDF files. Google, for instance, has an advanced search feature that allows users to filter results by file type. By specifying the file type as "PDF," users can find websites that offer free PDF downloads on a specific topic. While downloading Guide For Types Of Welds free PDF files is convenient, its important to note that copyright laws must be respected. Always ensure that the PDF files you download are legally available

for free. Many authors and publishers voluntarily provide free PDF versions of their work, but its essential to be cautious and verify the authenticity of the source before downloading Guide For Types Of Welds. In conclusion, the internet offers numerous platforms and websites that allow users to download free PDF files legally. Whether its classic literature, research papers, or magazines, there is something for everyone. The platforms mentioned in this article, such as Project Gutenberg, Open Library, Academia.edu, and Issuu, provide access to a vast collection of PDF files. However, users should always be cautious and verify the legality of the source before downloading Guide For Types Of Welds any PDF files. With these platforms, the world of PDF downloads is just a click away.

### FAQs About Guide For Types Of Welds Books

1. Where can I buy Guide For Types Of Welds books? Bookstores: Physical bookstores like Barnes & Noble, Waterstones, and independent local stores. Online Retailers: Amazon, Book Depository, and various online bookstores offer a wide range of books in physical and digital formats.
2. What are the different book formats available? Hardcover: Sturdy and durable, usually more expensive. Paperback: Cheaper, lighter, and more portable than hardcovers. E-books: Digital books available for e-readers like Kindle or software like Apple Books, Kindle, and Google Play Books.
3. How do I choose a Guide For Types Of Welds book to read? Genres: Consider the genre you enjoy (fiction, non-fiction, mystery, sci-fi, etc.). Recommendations: Ask friends, join book clubs, or explore online reviews and recommendations. Author: If you like a particular author, you might enjoy more of their work.
4. How do I take care of Guide For Types Of Welds books? Storage: Keep them away from direct sunlight and in a dry environment. Handling: Avoid folding pages, use bookmarks, and handle them with clean hands. Cleaning: Gently dust the covers and pages occasionally.
5. Can I borrow books without buying them? Public Libraries: Local libraries offer a wide range of books for borrowing. Book Swaps: Community book exchanges or online platforms where people exchange books.
6. How can I track my reading progress or manage my book collection? Book Tracking Apps: Goodreads, LibraryThing, and Book Catalogue are popular apps for tracking your reading progress and managing book collections. Spreadsheets: You can create your own spreadsheet to track books read, ratings, and other details.
7. What are Guide For Types Of Welds audiobooks, and where can I find them? Audiobooks: Audio recordings of books, perfect for listening while commuting or multitasking. Platforms: Audible, LibriVox, and Google Play Books offer a wide

selection of audiobooks.

8. How do I support authors or the book industry? Buy Books: Purchase books from authors or independent bookstores. Reviews: Leave reviews on platforms like Goodreads or Amazon. Promotion: Share your favorite books on social media or recommend them to friends.
9. Are there book clubs or reading communities I can join? Local Clubs: Check for local book clubs in libraries or community centers. Online Communities: Platforms like Goodreads have virtual book clubs and discussion groups.
10. Can I read Guide For Types Of Welds books for free? Public Domain Books: Many classic books are available for free as theyre in the public domain. Free E-books: Some websites offer free e-books legally, like Project Gutenberg or Open Library.

### Find Guide For Types Of Welds :

~~[honda cbr929rr 2000 2001 repair service manual](#)~~

*[honda 250 t service manual](#)*

[honda city zx service manual](#)

[honda aquatrax f 12x manual torrent](#)

**[honda civic 2008 technical manual](#)**

**[honda cb450 cb500 twins 1965 1 977 cylmer service manual](#)**

~~[honda cb 1100 sf service manual](#)~~

*[honda cbr400 service manual](#)*

*[honda civic repair manual 1989](#)*

**[honda atc 250r complete workshop repair manual 1985 1986](#)**

*[honda bf 40 manual](#)*

[honda city user manual](#)

**[honda 300ex repair manual 1996](#)**

**[honda civic electrical troubleshooting manual](#)**

**[honda cb1000r manual](#)**

### Guide For Types Of Welds :

[let it go from frozen sheet music for alto saxophone solo v2 - Mar 28 2023](#)

web idina menzel let it go from frozen for alto saxophone solo intermediate alto sax sheet music high quality and interactive transposable in any key play along includes an high quality pdf file to download instantly licensed to virtual sheet music by hal leonard publishing company

[saxophone version let it go frozen youtube](#) - Oct 23 2022

web for my daughters nanoomy juri i love you so much

**let it go from frozen sheet music for tenor saxophone solo** - Feb 24 2023

web idina menzel let it go from frozen for tenor saxophone solo intermediate tenor sax sheet music high quality and interactive transposable in any key play along includes an high quality pdf file to download instantly licensed to virtual sheet music by hal leonard publishing company

**frozen let it go saxophone cover youtube** - May 30 2023

web se vuoi sostenermi su patreon troverai tanti spartitiif you want to support me on patreon you will find many sheet music patreon com danielevita

[let it go alto sax sheet music musicsheets org](#) - Mar 16 2022

web 17 18 46 in order to continue read the entire sheet music of let it go alto sax you need to signup download music sheet notes in pdf format also available for offline reading instrument alto saxophone ensemble mixed level beginning read sheet music

**frozen let it go ismael dorado cover sax youtube** - Sep 02 2023

web dec 21 2015 let it go ismael dorado cover sax youtube frozen let it go ismael dorado cover sax sheet music partitura alto sax mymusicsheet com isma tenor soprano

**how to play let it go on saxophone music instruments** - Sep 21 2022

web mar 25 2023 let it go is a big ballad that has a lot of emotion and feeling behind it learning how to play let it go on the saxophone can be a challenge but it is a great song to learn the melody is mostly in the upper register of the saxophone so it can be tricky to get the hang of

[tenor saxophone play along let it go from frozen youtube](#) - Apr 28 2023

web dec 29 2021 this is a play along for bb tenor sax with piano accompaniment as backing track this is the famous song let it go from the movie frozen if you like this pie

**let s get it on song and lyrics by best saxophone tribute** - Jul 20 2022

web best saxophone tribute orchestra song 2013 listen to let s get it on on spotify best saxophone tribute orchestra song 2013 sign up log in home search your library create your first playlist it s easy we ll help you create playlist

















[let it go sheet music for saxophone alto solo musescore com](#) - Oct 03 2023

web jul 16 2021 download and print in pdf or midi free sheet music for let it go by kristen anderson lopez robert lopez arranged by tiago felipe dos santos for saxophone alto solo

**let s play let it go from frozen alto saxophone youtube** - Jun 30 2023

web let s play let it go from frozen alto saxophone youtube 0 01 1 35 let s play let it go from frozen alto saxophone songbird band sheet music 15 5k subscribers subscribe

let it go sax ruby ab key youtube - May 18 2022

web              adf   ad a91 

**let it go song and lyrics by bosaesonca spotify** - Apr 16 2022

web listen to let it go on spotify bosaesonca song 2015 bosaesonca song 2015 listen to let it go on spotify bosaesonca song 2015 home search your library create your first playlist it s easy we ll help you create playlist let s find some podcasts to

*let it go movie version eb instrument* - Jan 26 2023

web print and download let it go movie version eb instrument sheet music from frozen arranged for alto saxophone or baritone saxophone instrumental solo and instrumental part in d minor sku mn0128176

*frozen sax alto pdf scribd* - Jun 18 2022

web frozen sax alto free download as pdf file pdf text file txt or read online for free solo para sax alto

*let it go dave koz saxophone sheet music sax alto notes* - Aug 01 2023

web mar 22 2018 let it go dave koz saxophone sheet music sax alto notes you can download sheet music on my facebook page photo album saxophone transcription facebook com profile php

**let it go eb alto saxophone solo sheet music plus** - Nov 23 2022

web print and download let it go eb alto saxophone solo sheet music music notes for individual instrument part sheet music by idina menzel kristen anderson lopez hal leonard digital at sheet music plus

let it go sheet music for tenor saxophone solo pdf interactive - Aug 21 2022

web about let it go digital sheet music for tenor saxophone publisher hal leonard contributors to this music title paul barry writer this item includes pdf digital sheet music to download and print interactive sheet music for online playback transposition and printing you can transpose this music in any key

**let it go from frozen alto sax solo print sheet music now** - Dec 25 2022

web let it go from frozen lead sheet fake book let it go from frozen marimba solo let it go from frozen oboe solo let it go from frozen ocarina let it go from

*let it go on sax 2013 thecontemporaryaustin org* - Feb 12 2022

web never let me go top hits from tv movies musicals instrumental solos the canadian magazine the big book of disney songs

for trumpet 50 pop songs for kids for alto sax life aoa pop rock and movie instrumental solos essential songs for alto sax  
songbook songs from frozen tangled and enchanted 25 great sax solos let it go from frozen

**internet marketing integrating online and offline strategies** - Apr 11 2023

web internet marketing integrating online and offline strategies by roberts mary lou publication date 2012 topics internet  
marketing publisher mason oh south

**internet marketing integrating online and offline** - Jul 14 2023

web mcgraw hill irwin 2003 internet marketing 471 pages internet marketing integrating online and offline strategies asserts  
that while the internet is a transformational

istanbul exchanges ottomans orientalists and nineteenth - Dec 27 2021

**İstanbul karşılaşmaları mary roberts fiyat satın al d r** - Jan 28 2022

**internet marketing integrating online and offline strategies** - Dec 07 2022

web jan 1 2018 internet marketing integrating online and offline strategies in a digital environment fourth edition authors  
debra zahay saint edward s university mary lou

roberts mary lou department of history - Apr 30 2022

web mar 28 2012 internet marketing 3rd edition provides comprehensive coverage of the rapidly changing field of internet  
marketing that is timely and relevant it relies on

**internet marketing integrating online and offline strategies** - Mar 10 2023

web mary lou roberts debra l zahay south western cengage learning 2013 cybermarketing 484 pages internet marketing 3e  
international edition

internet marketing integrating online offline strategies - Oct 25 2021

**internet marketing loose leaf version amazon com** - Jun 01 2022

web mar 30 2017 she has been the editor in chief of the journal of research in interactive marketing since 2012 guiding the  
explosive growth in influence of that journal mary

*marla lou marlalou instagram photos and videos* - Nov 25 2021

**internet marketing integrating online and offline strategies** - Jun 13 2023

web internet marketing integrating online and offline strategies in a digital environment 4th ed authors mary lou roberts

abstract as a copyrighted textbook this is the only

**pdf review of mary roberts istanbul exchanges ottomans** - Feb 26 2022

internet marketing integrating online and offline - Nov 06 2022

web eser selen mary lou o neil this study presents oral history research which investigated the experiences of surviving women workers from the former cibali tekel tobacco and

**internet marketing integrating online and offline strategies in a** - Jul 02 2022

web 5 776 followers 3 297 following 797 posts see instagram photos and videos from marla lou marlalou

**internet marketing integrating online and offline** - Sep 04 2022

web tüm Özellikleri gör tüm formatlar 1 adet ciltli stoğu tükendi Ürün açıklaması İstanbul karşılaşmaları kitap açıklaması roberts İstanbul İmparatorluğu nun son döneminin ve

**amazon com internet marketing 9780357033883** - Feb 09 2023

web mar 28 2012 isbn 13 2901133625901 pub date 03 28 2012 publisher cengage learning internet marketing integrating online and offline strategies edition 3 by

internet marketing integrating online and offline strategies - Sep 23 2021

internet marketing debra zahay mary lou roberts google - Aug 15 2023

web aug 16 2019 internet marketing provides comprehensive coverage of the rapidly changing field of internet marketing that is timely and relevant it relies on extant

internet marketing 4th edition 9780357638576 - Oct 05 2022

web mary roberts this paper analyses the modern practice of collecting and displaying islamic art in ateliers and collector s houses in nineteenth century istanbul paris and krakow in

*mary lou o neil s research* - Mar 30 2022

internet marketing integrating online and offline - May 12 2023

web mar 28 2012 internet marketing integrating online and offline strategies mary lou roberts debra zahay cengage learning mar 28 2012 business economics 512

*internet marketing integrating online and offline* - Jan 08 2023

web internet marketing integrating online and offline strategies roberts mary lou published by cengage learning 2012 isbn 10 1133625908 isbn 13 9781133625902



**internet marketing integrating online and offline strategies** - Aug 03 2022

web in istanbul exchanges mary roberts offers an innovative way of understanding orientalism by shifting the focus from europe to istanbul and examining the cross cultural artistic

**timing belt diagram 3 5l 2004 chrysler pacifica fixya** - Nov 27 2022

web 1757 answers source i am installing a timing belt on a 2004 chrysler click on the following free direct link it has several diagrams including the serpentine belt diagram for your 2004 chrysler pacifica 3 5l dohc v6 it has the instructional and directional diagrams that will help you

*instructions for changing a timing belt on chrysler pacifica* - Mar 20 2022

web apr 27 2017 instructions for changing a timing belt on chrysler pacifica posted by angela warrenon apr 27 2017 want answer1 clicking this will make more experts see the question and we will remind you when it gets answered comment flag more

**diagram for a timing belt for 2006 chrysler pacifica fixya** - Dec 29 2022

web diagram for a timing belt for 2006 chrysler pacifica how to change a timing belt on a2006 chrysler pacifica posted by santiago quintero on apr 22 2013

2005 2006 chrysler pacifica v6 3 5l serpentine belt diagram - Sep 25 2022

web 2005 2006 chrysler pacifica v6 3 5l serpentine belt diagram 2007 ford fusion v6 3 0l serpentine belt diagram no comments mar 6 2018 2006 2008 ford escape and mercury mariner 2 3l and 3 0l serpentine belt diagram no comments jul 18 2014 2005 nissan altima l4 2 5l serpentine belt diagram

**chrysler pacifica bad timing belt or chain symptoms** - Jul 24 2022

web oct 16 2019 here are some of the most common warning signs of a bad timing belt on the chrysler pacifica 1 engine won t start if your pacifica s timing chain or belt has fallen off completely broken or has jumped a few teeth it is entirely possible that the engine won t even start

**chrysler pacifica and 3 5 engines timing alignment fix youtube** - Aug 05 2023

web apr 23 2016 in this video you will see what is going on and how to fix it also when adjusting the belt remember to take extra caution on the timing gears so you don t end up damaging anything take

does the chrysler pacifica have a timing belt or chain - May 22 2022

web jul 30 2020 the chrysler pacifica has a 3 6 l v6 engine that uses a timing chain instead of a timing belt one good reason for using a timing chain instead of a timing belt is that it usually doesn t need to be replaced however there are some unusual instances where it will need to be replaced such as it becoming loose or for some reason becoming

**change timing belt for 2004 pacifica fixya** - Aug 25 2022

web it has several diagrams including the serpentine belt diagram for your 2004 chrysler pacifica 3 5l dohc v6 it has the instructional and directional diagrams that will help you 2carpros com car repair information year 2004 make chrysler model pacifica 2004 chrysler pacifica drive belt routing diagram htm

**what is the timing belt on a pacifica startmycar** - Feb 28 2023

web as a general rule the life time of the timing belt oscillates between 37280 mi and 99420 mi or 5 years whichever comes first check the owner s manual of your pacifica to know the exact data of your car when changing the belt replace the tensioners as well

**chrysler pacifica timing belt replacement costs yourmechanic** - Feb 16 2022

web the timing belt allows the crankshaft to drive the camshafts in the cylinder head at half the rpms of the crankshaft the camshafts then open and close the engine s intake and exhaust valves in time with the movement and position of the pistons in the engine when to replace the timing belt every 60k 90k miles

**chrysler pacifica timing belt replacement repairsmith** - Jun 22 2022

web the best part we come to you with all the necessary tools and parts upfront pricing online booking quality service full warranty find a mechanic for a timing belt replacement although not all cars have timing belts those that do must have the belt replaced on a routine basis

2017 serpentine belt diagram 2017 chrysler pacifica minivan - Jun 03 2023

web apr 21 2021 it appears to be the diagram for the older 2004 2006 pacifica suv with the 3 5l the dead giveaways are the power steering pump and the lack of water pump which is driven by the timing belt on the 3 5l i ve attached the correct diagram below thanks for correcting that

08 chrysler pacifica 4 0 3 5 timing belt water pump replacement - May 02 2023

web aug 7 2021 timing belt and water pump replacement in a 08 chrysler pacifica this is a 4 0 engine but process should be similar if not exact for the 3 5

**get the best priced chrysler pacifica timing belt partsgeek** - Jan 30 2023

web here you can probably find a 2004 chrysler pacifica timing belt diagram and the suggested 2005 chrysler pacifica timing belt replacement interval if you can t find it in the owner s manual also included often are some detailed instructions about the steps to do the timing belt replacement

**chrysler pacifica timing belt or chain 2004 2023 autopadre** - Sep 06 2023

web jun 4 2023 all chrysler pacifica 3 6l and 3 8l engines have a timing chain and are interference while the 3 5l and the 4 0l engines have a timing belt and are interference scroll down to see detailed timing belt data for your particular model year of the chrysler pacifica chrysler pacifica timing belt or chain year

*2004 2023 chrysler pacifica timing belt or timing chain - Oct 07 2023*

web get accurate and up to date timing belt data for your chrysler pacifica by year and model 2004 2023 chrysler pacifica timing belt or timing chain timingbeltinfo com

*chrysler pacifica timing belt or timing chain - Oct 27 2022*

web timing belt or timing chain down below you will see a list with all chrysler pacifica models that have been produced they are classified by model identifier year and type of bodywork above each list we show you a series of pictures so that you can have a visual reference for each model

2004 chrysler pacifica serpentine belt routing and timing belt diagrams - Apr 20 2022

web 2004 chrysler pacifica serpentine belt routing and timing belt diagrams

pacifica i timing belt replacement forum chrysler club - Apr 01 2023

web timing belt kits like the facebook page find me here this video may work for other vehicles as well the timing belt kit does fit several makes and models i have listed some below 3 5l 4 0l very similar if way off post below in comments 2006 2007 2008 pacifica 2005 2006 2007 2008 2009 2010 chrysler 300

**chrysler pacifica serpentine belt routing and timing belt diagrams - Jul 04 2023**

web serpentine and timing belt diagrams 2005 2004