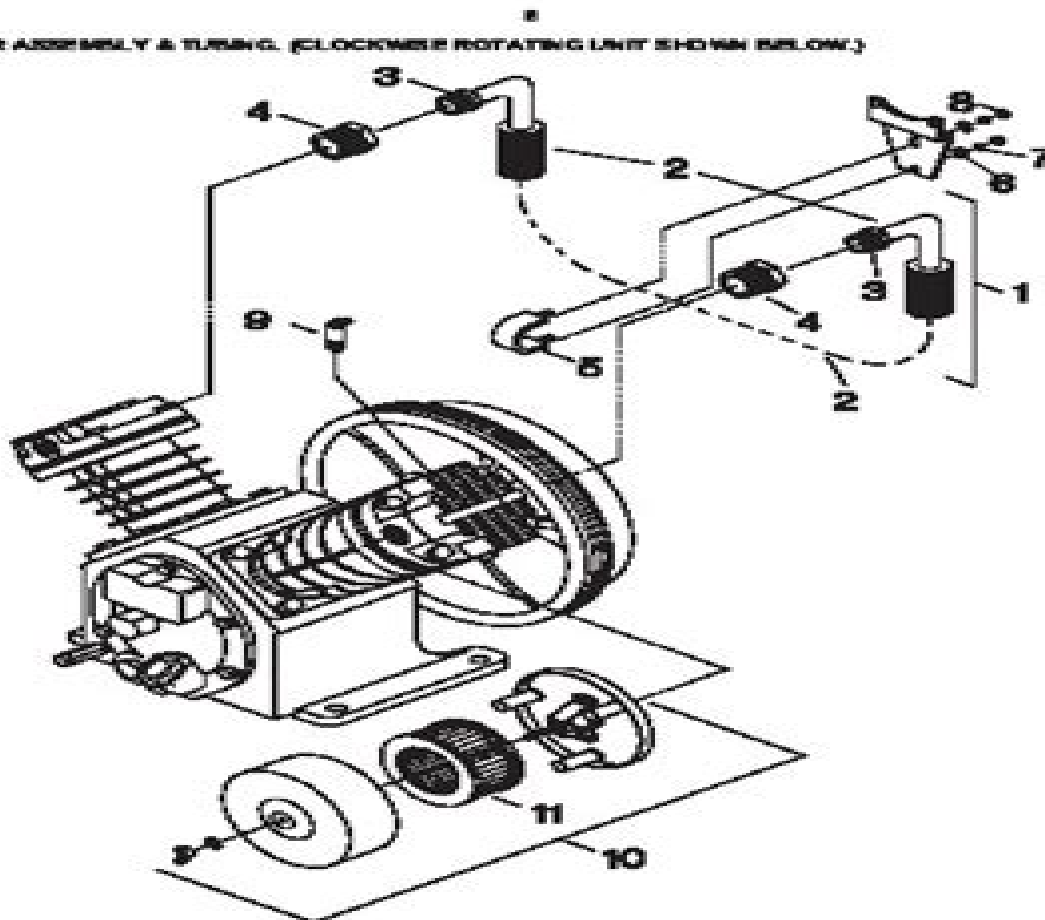

FIGURE 8. INTERCOOLER ASSEMBLY & TUBING. (CLOCKWISE ROTATING UNIT SHOWN BELOW.)



REF. NO.	CLOCKWISE PART NO.	COUNTER-CLOCKWISE PART NO.	DESCRIPTION	QTY.	SPARES		
					1	2	3
5-1	97331003	32290706	ASSY., INTERCOOLER	1		1	1
5-2	97330997	32295545	- INTERCOOLER	1			
5-3	95108577	95108577	- NUT, TUBE - 3/4"	2			
5-4	95080275	95031761	CONNECTOR, TUBE - 3/4" x 3/4"	2			
5-5	32247942	N/A	CLAMP, INTERCOOLER	1			
5-6	95094298	N/A	WASHER, FLAT - 1/4"	2			
5-7	32035479	N/A	LOCKWASHER, SPRING - 1/4"	2			
5-8	95419305	N/A	NUT, HEX - 1/4-20	2			
5-9	72062185	72062185	VALVE, RELIEF - 50 P.S.I.G.	1			
5-10	32170953	32170953	FILTER, INLET - COMPLETE	1		1	2
5-11	32170979	32170979	- ELEMENT, FILTER - 10 MICRON	1	1	1	1

# Ingersoll Rand T30 Air Compressor Manual

**SA Dillow**



## **Ingersoll Rand T30 Air Compressor Manual:**

Operator, Organizational, Direct and General Support, and Depot Maintenance Manual ,1973      **Textile World** ,1980  
Farmers and Consumers Market Bulletin ,2007      Operator's Manual ,1991      **Operator's Manual** ,1991      *Type 30*  
*Compressor Technician* Ingersoll-Rand Company,198?      **Instructions for the Care and Operation of Ingersoll-Rand**  
**Type Twenty Portable Air Compressors** Ingersoll-Rand Company,1933      *Instructions for the Care and Operation of*  
*Ingersoll-Rand Type Twenty Gasoline Engine Driven Portable Air Compressors* Ingersoll-Rand Company,1929      *Operator,*  
*Organizational, Field, and Depot Maintenance Manual* ,1963      **Service Manual** Caterpillar Inc.Peoria, Ill.,1992  
*Service Manual* Caterpillar Inc,1978      *A Manual for Air Compressors Users* Brunner Manufacturing Company,1930  
*Maintenance Manual and Parts Catalog* ,1942      **Le Roi Motorized Air Compressor, Model 105GA** ,1942  
*Portable Air Compressor* Construction Industry Manufacturers Association (U.S.),1987      Cummings ST 676 Two  
Cylinder Air Compressor Shop Manual Cummins Engine Company,1985      *Operator, Organizational, Direct Support,*  
*General Support, and Depot Maintenance Manual* ,1992      This Book Gives Complete Instructions for Erecting and  
Operating Class "ER-1" Straight-line, Belt Driven Air Compressors Ingersoll-Rand Company,1924      **Service Manual**  
Caterpillar Inc,1981      **Imperial Type Eleven Air Compressors** Ingersoll-Rand Company,1913

## The Enigmatic Realm of **Ingersoll Rand T30 Air Compressor Manual**: Unleashing the Language is Inner Magic

In a fast-paced digital era where connections and knowledge intertwine, the enigmatic realm of language reveals its inherent magic. Its capacity to stir emotions, ignite contemplation, and catalyze profound transformations is nothing short of extraordinary. Within the captivating pages of **Ingersoll Rand T30 Air Compressor Manual** a literary masterpiece penned with a renowned author, readers attempt a transformative journey, unlocking the secrets and untapped potential embedded within each word. In this evaluation, we shall explore the book's core themes, assess its distinct writing style, and delve into its lasting effect on the hearts and minds of people who partake in its reading experience.

<http://www.armchairempire.com/book/book-search/HomePages/Hewlett%20Packard%20Vectra%20Ve%20Manual.pdf>

### **Table of Contents Ingersoll Rand T30 Air Compressor Manual**

1. Understanding the eBook Ingersoll Rand T30 Air Compressor Manual
  - The Rise of Digital Reading Ingersoll Rand T30 Air Compressor Manual
  - Advantages of eBooks Over Traditional Books
2. Identifying Ingersoll Rand T30 Air Compressor Manual
  - Exploring Different Genres
  - Considering Fiction vs. Non-Fiction
  - Determining Your Reading Goals
3. Choosing the Right eBook Platform
  - Popular eBook Platforms
  - Features to Look for in an Ingersoll Rand T30 Air Compressor Manual
  - User-Friendly Interface
4. Exploring eBook Recommendations from Ingersoll Rand T30 Air Compressor Manual
  - Personalized Recommendations
  - Ingersoll Rand T30 Air Compressor Manual User Reviews and Ratings
  - Ingersoll Rand T30 Air Compressor Manual and Bestseller Lists

5. Accessing Ingersoll Rand T30 Air Compressor Manual Free and Paid eBooks
  - Ingersoll Rand T30 Air Compressor Manual Public Domain eBooks
  - Ingersoll Rand T30 Air Compressor Manual eBook Subscription Services
  - Ingersoll Rand T30 Air Compressor Manual Budget-Friendly Options
6. Navigating Ingersoll Rand T30 Air Compressor Manual eBook Formats
  - ePub, PDF, MOBI, and More
  - Ingersoll Rand T30 Air Compressor Manual Compatibility with Devices
  - Ingersoll Rand T30 Air Compressor Manual Enhanced eBook Features
7. Enhancing Your Reading Experience
  - Adjustable Fonts and Text Sizes of Ingersoll Rand T30 Air Compressor Manual
  - Highlighting and Note-Taking Ingersoll Rand T30 Air Compressor Manual
  - Interactive Elements Ingersoll Rand T30 Air Compressor Manual
8. Staying Engaged with Ingersoll Rand T30 Air Compressor Manual
  - Joining Online Reading Communities
  - Participating in Virtual Book Clubs
  - Following Authors and Publishers Ingersoll Rand T30 Air Compressor Manual
9. Balancing eBooks and Physical Books Ingersoll Rand T30 Air Compressor Manual
  - Benefits of a Digital Library
  - Creating a Diverse Reading Collection Ingersoll Rand T30 Air Compressor Manual
10. Overcoming Reading Challenges
  - Dealing with Digital Eye Strain
  - Minimizing Distractions
  - Managing Screen Time
11. Cultivating a Reading Routine Ingersoll Rand T30 Air Compressor Manual
  - Setting Reading Goals Ingersoll Rand T30 Air Compressor Manual
  - Carving Out Dedicated Reading Time
12. Sourcing Reliable Information of Ingersoll Rand T30 Air Compressor Manual
  - Fact-Checking eBook Content of Ingersoll Rand T30 Air Compressor Manual
  - Distinguishing Credible Sources
13. Promoting Lifelong Learning

- Utilizing eBooks for Skill Development
  - Exploring Educational eBooks
14. Embracing eBook Trends
- Integration of Multimedia Elements
  - Interactive and Gamified eBooks

### **Ingersoll Rand T30 Air Compressor Manual Introduction**

In today's digital age, the availability of Ingersoll Rand T30 Air Compressor Manual books and manuals for download has revolutionized the way we access information. Gone are the days of physically flipping through pages and carrying heavy textbooks or manuals. With just a few clicks, we can now access a wealth of knowledge from the comfort of our own homes or on the go. This article will explore the advantages of Ingersoll Rand T30 Air Compressor Manual books and manuals for download, along with some popular platforms that offer these resources. One of the significant advantages of Ingersoll Rand T30 Air Compressor Manual books and manuals for download is the cost-saving aspect. Traditional books and manuals can be costly, especially if you need to purchase several of them for educational or professional purposes. By accessing Ingersoll Rand T30 Air Compressor Manual versions, you eliminate the need to spend money on physical copies. This not only saves you money but also reduces the environmental impact associated with book production and transportation. Furthermore, Ingersoll Rand T30 Air Compressor Manual books and manuals for download are incredibly convenient. With just a computer or smartphone and an internet connection, you can access a vast library of resources on any subject imaginable. Whether you're a student looking for textbooks, a professional seeking industry-specific manuals, or someone interested in self-improvement, these digital resources provide an efficient and accessible means of acquiring knowledge. Moreover, PDF books and manuals offer a range of benefits compared to other digital formats. PDF files are designed to retain their formatting regardless of the device used to open them. This ensures that the content appears exactly as intended by the author, with no loss of formatting or missing graphics. Additionally, PDF files can be easily annotated, bookmarked, and searched for specific terms, making them highly practical for studying or referencing. When it comes to accessing Ingersoll Rand T30 Air Compressor Manual books and manuals, several platforms offer an extensive collection of resources. One such platform is Project Gutenberg, a nonprofit organization that provides over 60,000 free eBooks. These books are primarily in the public domain, meaning they can be freely distributed and downloaded. Project Gutenberg offers a wide range of classic literature, making it an excellent resource for literature enthusiasts. Another popular platform for Ingersoll Rand T30 Air Compressor Manual books and manuals is Open Library. Open Library is an initiative of the Internet Archive, a non-profit organization dedicated to digitizing cultural artifacts and making them accessible to the public. Open Library hosts millions

of books, including both public domain works and contemporary titles. It also allows users to borrow digital copies of certain books for a limited period, similar to a library lending system. Additionally, many universities and educational institutions have their own digital libraries that provide free access to PDF books and manuals. These libraries often offer academic texts, research papers, and technical manuals, making them invaluable resources for students and researchers. Some notable examples include MIT OpenCourseWare, which offers free access to course materials from the Massachusetts Institute of Technology, and the Digital Public Library of America, which provides a vast collection of digitized books and historical documents. In conclusion, Ingersoll Rand T30 Air Compressor Manual books and manuals for download have transformed the way we access information. They provide a cost-effective and convenient means of acquiring knowledge, offering the ability to access a vast library of resources at our fingertips. With platforms like Project Gutenberg, Open Library, and various digital libraries offered by educational institutions, we have access to an ever-expanding collection of books and manuals. Whether for educational, professional, or personal purposes, these digital resources serve as valuable tools for continuous learning and self-improvement. So why not take advantage of the vast world of Ingersoll Rand T30 Air Compressor Manual books and manuals for download and embark on your journey of knowledge?

### **FAQs About Ingersoll Rand T30 Air Compressor Manual Books**

How do I know which eBook platform is the best for me? Finding the best eBook platform depends on your reading preferences and device compatibility. Research different platforms, read user reviews, and explore their features before making a choice. Are free eBooks of good quality? Yes, many reputable platforms offer high-quality free eBooks, including classics and public domain works. However, make sure to verify the source to ensure the eBook credibility. Can I read eBooks without an eReader? Absolutely! Most eBook platforms offer webbased readers or mobile apps that allow you to read eBooks on your computer, tablet, or smartphone. How do I avoid digital eye strain while reading eBooks? To prevent digital eye strain, take regular breaks, adjust the font size and background color, and ensure proper lighting while reading eBooks. What the advantage of interactive eBooks? Interactive eBooks incorporate multimedia elements, quizzes, and activities, enhancing the reader engagement and providing a more immersive learning experience. Ingersoll Rand T30 Air Compressor Manual is one of the best book in our library for free trial. We provide copy of Ingersoll Rand T30 Air Compressor Manual in digital format, so the resources that you find are reliable. There are also many Ebooks of related with Ingersoll Rand T30 Air Compressor Manual. Where to download Ingersoll Rand T30 Air Compressor Manual online for free? Are you looking for Ingersoll Rand T30 Air Compressor Manual PDF? This is definitely going to save you time and cash in something you should think about. If you trying to find then search around for online. Without a doubt there are numerous these available and

many of them have the freedom. However without doubt you receive whatever you purchase. An alternate way to get ideas is always to check another Ingersoll Rand T30 Air Compressor Manual. This method for see exactly what may be included and adopt these ideas to your book. This site will almost certainly help you save time and effort, money and stress. If you are looking for free books then you really should consider finding to assist you try this. Several of Ingersoll Rand T30 Air Compressor Manual are for sale to free while some are payable. If you arent sure if the books you would like to download works with for usage along with your computer, it is possible to download free trials. The free guides make it easy for someone to free access online library for download books to your device. You can get free download on free trial for lots of books categories. Our library is the biggest of these that have literally hundreds of thousands of different products categories represented. You will also see that there are specific sites catered to different product types or categories, brands or niches related with Ingersoll Rand T30 Air Compressor Manual. So depending on what exactly you are searching, you will be able to choose e books to suit your own need. Need to access completely for Campbell Biology Seventh Edition book? Access Ebook without any digging. And by having access to our ebook online or by storing it on your computer, you have convenient answers with Ingersoll Rand T30 Air Compressor Manual To get started finding Ingersoll Rand T30 Air Compressor Manual, you are right to find our website which has a comprehensive collection of books online. Our library is the biggest of these that have literally hundreds of thousands of different products represented. You will also see that there are specific sites catered to different categories or niches related with Ingersoll Rand T30 Air Compressor Manual So depending on what exactly you are searching, you will be able to choose ebook to suit your own need. Thank you for reading Ingersoll Rand T30 Air Compressor Manual. Maybe you have knowledge that, people have search numerous times for their favorite readings like this Ingersoll Rand T30 Air Compressor Manual, but end up in harmful downloads. Rather than reading a good book with a cup of coffee in the afternoon, instead they juggled with some harmful bugs inside their laptop. Ingersoll Rand T30 Air Compressor Manual is available in our book collection an online access to it is set as public so you can download it instantly. Our digital library spans in multiple locations, allowing you to get the most less latency time to download any of our books like this one. Merely said, Ingersoll Rand T30 Air Compressor Manual is universally compatible with any devices to read.

### **Find Ingersoll Rand T30 Air Compressor Manual :**

*hewlett packard vectra ve manual*

*hide and shriek mighty mighty monsters*

[hewlett packard j6480 manual](#)

[hhr owners manual](#)

[highlights hidden pictures® favorite friendship puzzles favorite hidden pictures®](#)



**highcharts cookbook terwoord nicholas**

[hilux surf workshop manual](#)

[hewlett packard p2015dn manual](#)

[hewlett packard user manuals](#)

**hinh phu nu dung khoe lon**

[hetzjagd im all alfred bekker](#)

[high achieving schools of aga khan university examination board leadership roles and practices](#)

**high performance cars a coloring book of cars volume 1**

[high school physics multiple choice questions](#)

[hiding from humanity disgust shame and the law princeton paperbacks paperback january 22 2006](#)

**Ingersoll Rand T30 Air Compressor Manual :**

[fire and sword book 3 throne of the caesars hardcover](#) - Jul 02 2022

web absorbing and brilliant game of thrones without the dragons the times the third book in sidebottom s epic series set in third century rome a dramatic era of murder

*fire and sword throne of the caesars book 3 paperback* - Aug 03 2022

web amazon in buy fire and sword book 3 throne of the caesars book online at best prices in india on amazon in read fire and sword book 3 throne of the caesars

[fire and sword throne of the caesars book 3 google books](#) - Jan 08 2023

web fire and sword book 3 throne of the caesars by sidebottom harry at abebooks co uk isbn 10 0007499957 isbn 13 9780007499953 harpercollins 2017 softcover

**fire and sword throne of the caesars book 3 kindle** - Feb 09 2023

web game of thrones without the dragons the times the third book in sidebottom s epic series set in third century rome a dramatic era of murder coup counter rebellions and

**fire and sword throne of the caesars book 3 kindle edition** - Jan 28 2022

web absorbing and brilliant game of thrones without the dragons the times the third book in sidebottom s epic series set in third century rome a dramatic era of murder

**fire and sword throne of the caesars book 3 google play** - Sep 04 2022

web may 19 2016 fire and sword throne of the caesars book 3 sidebottom harry amazon ca books

*fire sword throne of the caesars book 3* - Aug 15 2023

web fire and sword throne of the caesars book 3 sidebottom harry amazon com tr kitap  
**fire and sword throne of caesars book three** - Nov 25 2021

fire and sword throne of the caesars book 3 ebooks com - Dec 27 2021

web fire sword throne of the caesars band 3 sidebottom harry amazon com tr kitap

*fire and sword book 3 throne of the caesars amazon in* - Apr 30 2022

web may 19 2016 fire and sword is the third book in the acclaimed series throne of the caesars and follows his bestselling series warrior of rome he divides his time

*fire and sword book 3 throne of the caesars* - May 12 2023

web fire and sword harry sidebottom 4 02 271 ratings22 reviews want to read kindle 9 99 rate this book absorbing and brilliant game of thrones without the dragons the

**fire and sword throne of caesars book three google books** - Mar 10 2023

web may 19 2016 fire and sword throne of the caesars book 3 kindle edition by sidebottom harry download it once and read it on your kindle device pc phones or

**fire and sword book 3 throne of the caesars** - Jun 13 2023

web fire and sword is the third book in the acclaimed series throne of the caesars and follows his bestselling series warrior of rome he divides his time between oxford and

fire and sword throne of the caesars book 3 amazon com tr - Jul 14 2023

web may 19 2016 fire and sword is the third book in the acclaimed series throne of the caesars and follows his bestselling series warrior of rome he divides his time

**fire and sword throne of the caesars book 3 kindle edition** - Feb 26 2022

web filled with intrigue betrayal and bloody battle fire sword creates a magnificent world built on brutality and political games where no one is safe from retribution not even

fire sword throne of the caesars book 3 by harry - Nov 06 2022

web with the gordiani father and son dead in africa the tyrant maximinus thrax vies to reclaim the throne the senate who supported the revolt of the gordiani must act quickly to

fire and sword book 3 throne of the caesars abebooks - Dec 07 2022

web in one of the greatest sieges in all of history the fate of the empire will be decided the dramatic and thrilling tale of murder rebellion and civil war fire and sword creates a

fire sword throne of the caesars band 3 kağıt kapak - Oct 25 2021

[fire and sword throne of the caesars book 3 google books](#) - Oct 05 2022

web fire and sword throne of the caesars book 3 ebook written by harry sidebottom read this book using google play books app on your pc android ios devices

[fire and sword throne of the caesars book 3 ebooks com](#) - Jun 01 2022

web 399 00 fulfilled free delivery on orders over 499 details sold by uread store see this image read sample follow the author harry sidebottom fire and sword book 3

[fire and sword throne of the caesars 3 goodreads](#) - Apr 11 2023

web mar 28 2017 fire and sword throne of caesars book three author harry sidebottom edition illustrated reprint publisher harry n abrams 2017 isbn

[fire and sword throne of the caesars book 3 paperback](#) - Mar 30 2022

web may 19 2016 fire and sword throne of the caesars book 3 ebook sidebottom harry amazon co uk kindle store

[gastrointestinal system anatomy and physiology osmosis](#) - Feb 28 2023

web the gastrointestinal tract is made up of the mouth pharynx esophagus stomach small intestine large intestine and finally the anal canal the accessory organs include the teeth tongue salivary glands the liver gallbladder and the pancreas the main job of the gastrointestinal system is ingestion taking in food digestion breaking

**23 1 overview of the digestive system anatomy and physiology** - Apr 01 2023

web highlights learning objectives by the end of this section you will be able to identify the organs of the alimentary canal from proximal to distal and briefly state their function identify the accessory digestive organs and briefly state their function describe the four fundamental tissue layers of the alimentary canal

[22 1a anatomy of the digestive system medicine libretexts](#) - Jun 22 2022

web jan 17 2023 key points the major organs of the digestive system are the stomach and intestine the upper gastrointestinal tract consists of the esophagus stomach and duodenum the lower gastrointestinal tract includes the small intestine and the large intestine digestive juices are produced by the pancreas and the gallbladder

[digestive system lecture notes](#) - Nov 27 2022

web the organs of digestive system gastrointestinal gi tract is a continuous tube that extends from the mouth to the anus through the thoracic and abdominopelvic cavities organs include 1 mouth 2 pharynx 3 esophagus 4 stomach 5 small intestine 6 and large intestine accessory digestive organs that participate in

[digestive system anatomy and physiology nurseslabs](#) - Apr 20 2022

web sep 14 2023 anatomy of the digestive system organs of the alimentary canal mouth pharynx esophagus stomach small intestine large intestine accessory digestive organs teeth salivary glands pancreas liver gallbladder physiology of the

digestive system activities occurring in the mouth pharynx and esophagus activities of the stomach

**ch 22 pearson digestive system quizzes flashcards quizlet** - Jul 24 2022

web splanchnic circulation involves the blood supply that feeds and drains abdominal reproductive organs thoracic digestive organs abdominal digestive organs or thoracic cardiovascular organs abdominal digestive organs true or false the digestive system is regulated by the sympathetic parasympathetic and entire nervous systems true

*physiology of digestion and absorption video tutorial pearson* - May 02 2023

web learn physiology of digestion and absorption with free step by step video explanations and practice problems by experienced tutors

**physiology digestion statpearls ncbi bookshelf** - Sep 25 2022

web sep 12 2022 bookshelf id nbk544242 pmid 31334962 digestion is the process of mechanically and enzymatically breaking down food into substances for absorption into the bloodstream the food contains three macronutrients that require digestion before they can be absorbed fats carbohydrates and proteins through the process of digestion these

*digestive system pearson s anatomy lab test flashcards* - May 22 2022

web oct 21 2023 large intestine identify the what digestive system organ this slide represents fauces the two pillars formed by the palatoglossus and the palatopharyngeus muscle respectively and covered with mucous membrane parotid salivary glands glands occur near the mouth and the left ear and the mouth and right ear

physiology of digestion and absorption video tutorial pearson - Oct 07 2023

web absorption of fats in small intestine ak lectures 201 multiple choice the major site for nutrient absorption is the 458

learn physiology of digestion and absorption with free step by step video explanations and practice problems by

*overview general features video tutorial practice pearson* - Jun 03 2023

web the enteric nervous system is the in house nerve supply of the alimentary canal which regulatory chemical stimulates gastric gland activity and motility the short reflexes in the digestive system are stimulated by learn overview general features with free step by step video explanations and practice problems by experienced tutors

**digestive system human anatomy physiology** - Mar 20 2022

web introduction 23 1 overview of the digestive system 23 2 digestive system processes and regulation 23 3 the mouth pharynx and esophagus 23 4 the stomach 23 5 the small and large intestines 23 6 accessory organs in digestion the liver pancreas and gallbladder 23 7 chemical digestion and absorption a closer look video tutorials

**human anatomy and physiology pearson unit 4 exam** - Jan 30 2023

web human anatomy and physiology pearson unit 4 exam term 1 181 the digestive system click the card to flip definition 1 181 takes in food breaks it down into nutrient molecules absorbs nutrients into the blood stream

**the digestive system channels for pearson** - Sep 06 2023

web the digestive system channels for pearson general biology 39 digestive system digestion

[anat 1053 unit 8 digestive system student slides september 2018](#) - Aug 25 2022

web digestive system anat 1053 unit digestive system pearson education inc education inc 2015 2015 pearson what hydrolysis proteins carbohydrates lipids skip to document ask an expert course anatomy and physiology ii anat 1053 65 documents students shared 65 documents in this course info more info download save 1

[pdf physiology of the digestive system researchgate](#) - Feb 16 2022

web may 22 2021 abstract the digestive system composed of the gastrointestinal tract git or alimentary canal and accessory organs 1 alimentary canal mouth pharynx esophagus stomach small intestine

[unit 27 anatomy and physiology the digestive system](#) - Oct 27 2022

web this unit aims to give learners an understanding of the anatomy and physiology of the digestive system common diseases affecting the digestive system and the range of healthcare science services used in the diagnosis treatment and monitoring of diseases of this system unit assessment requirements

[23 1 overview of the digestive system anatomy physiology](#) - Jul 04 2023

web the digestive system includes the organs of the alimentary canal and accessory structures the alimentary canal forms a continuous tube that is open to the outside environment at both ends the organs of the alimentary canal are the mouth pharynx esophagus stomach small intestine and large intestine

**digestive system part 1 crash course anatomy physiology 33 pearson** - Aug 05 2023

web digestive system digestion 4m digestive system part 1 crash course anatomy physiology 33 crashcourse 787 was this helpful video video comments 0 be the

**digestive system anatomy organs functions kenhub** - Dec 29 2022

web nov 2 2023 extending from the mouth to the anus the digestive tract is one of the largest systems in the human body it contains organs that regulate food intake its digestion and absorption of the useful materia that it contains

**il te faut partir à l aube by wole soyinka** - Feb 10 2023

web il te faut partir à l aube est la mémoire d une vie publique passionnante une méditation sur la justice et la tyrannie un testament fascinant légué à un pays ravagé mais plein d aspirations

[il te faut partir à l aube de wole soyinka grand format decitre](#) - Mar 11 2023

web oct 2 2007 il te faut partir à l aube est la mémoire d une vie publique passionnante une méditation sur la justice et la tyrannie un testament fascinant légué à un pays ravagé mais plein d aspirations

**il te faut partir à l aube by wole soyinka** - Jul 03 2022

web il te faut partir à l aube est la mémoire d une vie publique passionnante une méditation sur la justice et la tyrannie un testament fascinant légué à un pays ravagé mais plein d aspirations

**il te faut partir à l aube wole soyinka payot** - Jan 09 2023

web il te faut partir à l aube est le troisième volet tout aussi grinçant des mémoires de soyinka le livre s ouvre au moment où traqué par la police il dut improviser le plus douloureux des exils

*il te faut partir à l aube by wole soyinka* - Jan 29 2022

web ayaye l aube part2 clip officiel il te faut partir l aube mmoires book 2007 il te faut partir l aube french edition

9782742770335 il te faut partir l aube mmoires de wole soyinka premier africain à recevoir le prix nobel de littérature et militant politique aux initiatives prodigieuses wole soyinka donne ici une suite à





























































il te faut partir à l aube by wole soyinka - Dec 28 2021

web il te faut partir à l aube est la mémoire d une vie publique passionnante une méditation sur la justice et la tyrannie un testament fascinant légué à un pays

**translation of il faut partir à l aube in english reverso context** - Jun 14 2023

web translations in context of il faut partir à l aube in french english from reverso context on doit se lever tôt il faut partir à l aube

**traduction aube en arabe dictionnaire français arabe reverso** - Mar 31 2022

web pour beaucoup ce fut l aube d une ère nouvelle                     mais depuis l aube de l après midi bitcoin a de nouveau attiré l attention des gens                                         sur les quais à regarder l aube

*il te faut partir à l aube actes sud* - Jul 15 2023

web wole soyinka deuxième volume des mémoires de wole soyinka ce livre incomparable de grande et de petites histoires retracent ces trente dernières années de tumulte de violence et de passions au nigéria

il te faut partir à l aube france loisirs suisse - Sep 05 2022

web sep 28 2007 il te faut partir à l aube france loisirs suisse achat avec 20 à 30 d économie sur les meilleurs livres cd dvd blu ray et jeux vidéos

*il te faut partir à l aube wole soyinka babelio* - Aug 16 2023

web sep 28 2007 dans il te faut partir à l aube l auteur nous expose l architecture d une dictature qui s explose comme un héritage à la violence ce livre est beau récit par lequel il nous relate sa vie de d exilé et celle de son retour

il te faut partir à l aube mémoires broché fnac - May 13 2023

web mémoires il te faut partir à l aube wole soyinka etienne galle actes sud des milliers de livres avec la livraison chez vous

en 1 jour ou en magasin avec 5 de réduction il te faut partir à l aube mémoires broché wole soyinka etienne galle achat livre fnac

[il te faut partir a l aube 2022 vpn bethnalgreenventures](#) - May 01 2022

web soyinka est la voix des droits de l homme de la démocratie et de la liberté il te faut partir à l aube est la mémoire d une vie publique passionnante une méditation sur la justice et la tyrannie un testament fascinant légué à un pays ravagé mais plein d aspirations le conscrit de 1813 brill

**il te faut partir à l aube broché wole soyinka etienne galle** - Dec 08 2022

web fnac mémoires il te faut partir à l aube wole soyinka etienne galle actes sud livraison chez vous ou en magasin et 5 sur tous les livres achetez neuf ou d occasion

*il te faut partir à l aube by wole soyinka secure4 khronos* - Aug 04 2022

web jun 11 2023 il te faut partir à l aube est la mémoire d une vie publique passionnante une méditation sur la justice et la tyrannie un testament fascinant légué à un pays ravagé mais plein d aspirations secure4 khronos org 1 9

[il te faut partir à l aube wole soyinka senscritique](#) - Apr 12 2023

web il te faut partir à l aube est un livre de wole soyinka résumé deuxième volume des mémoires de wole soyinka ce livre incomparable de grande et de petites histoires

[il faut partir spotify song and lyrics by aline spotify](#) - Feb 27 2022

web listen to il faut partir spotify on spotify aline song 2013 aline song 2013 listen to il faut partir spotify on spotify aline song 2013 sign up log in home search your library create your first playlist it s easy we ll help you create playlist let s find some podcasts to

*il te faut partir à l aube label emmaüs* - Oct 06 2022

web il te faut partir à l aubepremier africain à recevoir le prix nobel de littérature et militant politique aux initiatives prodigieuses

*il te faut partir à l aube* □□ □□□□ - Jun 02 2022

web il te faut partir à l aube □□ wole soyinka □□□ actes sud □□□ 2007 9 28 □□ 649 □□ eur 28 00 □□ broché isbn 9782742770335 □□□□

[il te faut partir à l aube mémoires amazon fr](#) - Nov 07 2022

web il te faut partir à l aube mémoires relié livre grand format 28 septembre 2007 de wole soyinka auteur etienne galle traduction 4 8 4 8 sur 5 étoiles 4 évaluations