













<b>Operator's Manual</b>	READ CAREFULLY		
<b>Manuale d'istruzioni</b>	LEGGERE ATTENTAMENTE		
<b>Manuel d'instructions</b>	LIRE ATTENTIVEMENT		
<b>Bedienungsanleitung</b>	SORGFÄLTIG LESEN		
<b>Manual de instrucciones</b>	LEER ATENTAMENTE		
<b>Gebruikershandleiding</b>	ERST GOED DOORLEZEN		
<b>Ägarhandbok</b>	LÁS NOGA		
<b>Brughåndbog</b>	LÆS OMHYGGELIGT		
<b>Omistajankäsikirja</b>	LUE HUOLELLISESTI		
<b>Eierens Håndbok</b>	LES NOYE		
<b>Manual de Instruções</b>	LER ATENTAMENTE		
<b>ΟΔΗΓΙΕΣ ΧΡΗΣΕΩΣ</b>	ΔΙΑΒΑΣΤΕ ΠΡΟΣΕΚΤΙΚΑ		
<b>Használati útmutató</b>	FIGYELEMMEL OLVASANDÓ		



CE

# Mcculloch Chainsaw Manual Free

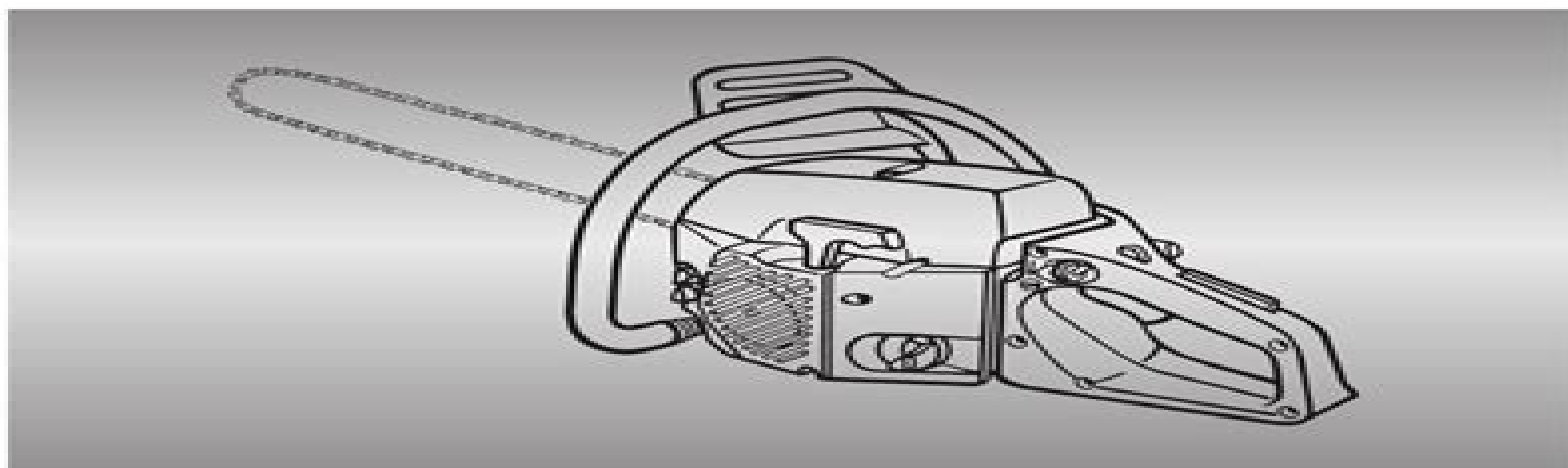
**Patrick Vollmar**



**Mcculloch Chainsaw Manual Free:**

## Unveiling the Power of Verbal Beauty: An Mental Sojourn through **Mcculloch Chainsaw Manual Free**

In a world inundated with screens and the cacophony of instantaneous transmission, the profound power and emotional resonance of verbal beauty often disappear in to obscurity, eclipsed by the continuous assault of sound and distractions. However, situated within the lyrical pages of **Mcculloch Chainsaw Manual Free**, a charming function of fictional beauty that impulses with fresh feelings, lies an wonderful journey waiting to be embarked upon. Composed by a virtuoso wordsmith, this interesting opus courses visitors on a mental odyssey, softly exposing the latent possible and profound affect stuck within the complicated internet of language. Within the heart-wrenching expanse with this evocative examination, we can embark upon an introspective exploration of the book is key styles, dissect their fascinating publishing style, and immerse ourselves in the indelible impression it leaves upon the depths of readers souls.

<http://www.armchairempire.com/data/scholarship/index.jsp/Leaving%20Certificate%20Exam%20Papers%20Lcvp%20Past%20Exam%20Papers.pdf>

### **Table of Contents Mcculloch Chainsaw Manual Free**

1. Understanding the eBook Mcculloch Chainsaw Manual Free
  - The Rise of Digital Reading Mcculloch Chainsaw Manual Free
  - Advantages of eBooks Over Traditional Books
2. Identifying Mcculloch Chainsaw Manual Free
  - Exploring Different Genres
  - Considering Fiction vs. Non-Fiction
  - Determining Your Reading Goals
3. Choosing the Right eBook Platform
  - Popular eBook Platforms
  - Features to Look for in an Mcculloch Chainsaw Manual Free
  - User-Friendly Interface
4. Exploring eBook Recommendations from Mcculloch Chainsaw Manual Free

- Personalized Recommendations
  - Mcculloch Chainsaw Manual Free User Reviews and Ratings
  - Mcculloch Chainsaw Manual Free and Bestseller Lists
5. Accessing Mcculloch Chainsaw Manual Free Free and Paid eBooks
    - Mcculloch Chainsaw Manual Free Public Domain eBooks
    - Mcculloch Chainsaw Manual Free eBook Subscription Services
    - Mcculloch Chainsaw Manual Free Budget-Friendly Options
  6. Navigating Mcculloch Chainsaw Manual Free eBook Formats
    - ePub, PDF, MOBI, and More
    - Mcculloch Chainsaw Manual Free Compatibility with Devices
    - Mcculloch Chainsaw Manual Free Enhanced eBook Features
  7. Enhancing Your Reading Experience
    - Adjustable Fonts and Text Sizes of Mcculloch Chainsaw Manual Free
    - Highlighting and Note-Taking Mcculloch Chainsaw Manual Free
    - Interactive Elements Mcculloch Chainsaw Manual Free
  8. Staying Engaged with Mcculloch Chainsaw Manual Free
    - Joining Online Reading Communities
    - Participating in Virtual Book Clubs
    - Following Authors and Publishers Mcculloch Chainsaw Manual Free
  9. Balancing eBooks and Physical Books Mcculloch Chainsaw Manual Free
    - Benefits of a Digital Library
    - Creating a Diverse Reading Collection Mcculloch Chainsaw Manual Free
  10. Overcoming Reading Challenges
    - Dealing with Digital Eye Strain
    - Minimizing Distractions
    - Managing Screen Time
  11. Cultivating a Reading Routine Mcculloch Chainsaw Manual Free
    - Setting Reading Goals Mcculloch Chainsaw Manual Free
    - Carving Out Dedicated Reading Time
  12. Sourcing Reliable Information of Mcculloch Chainsaw Manual Free

- Fact-Checking eBook Content of Mcculloch Chainsaw Manual Free
  - Distinguishing Credible Sources
13. Promoting Lifelong Learning
    - Utilizing eBooks for Skill Development
    - Exploring Educational eBooks
  14. Embracing eBook Trends
    - Integration of Multimedia Elements
    - Interactive and Gamified eBooks

### **Mcculloch Chainsaw Manual Free Introduction**

In today's digital age, the availability of Mcculloch Chainsaw Manual Free books and manuals for download has revolutionized the way we access information. Gone are the days of physically flipping through pages and carrying heavy textbooks or manuals. With just a few clicks, we can now access a wealth of knowledge from the comfort of our own homes or on the go. This article will explore the advantages of Mcculloch Chainsaw Manual Free books and manuals for download, along with some popular platforms that offer these resources. One of the significant advantages of Mcculloch Chainsaw Manual Free books and manuals for download is the cost-saving aspect. Traditional books and manuals can be costly, especially if you need to purchase several of them for educational or professional purposes. By accessing Mcculloch Chainsaw Manual Free versions, you eliminate the need to spend money on physical copies. This not only saves you money but also reduces the environmental impact associated with book production and transportation. Furthermore, Mcculloch Chainsaw Manual Free books and manuals for download are incredibly convenient. With just a computer or smartphone and an internet connection, you can access a vast library of resources on any subject imaginable. Whether you're a student looking for textbooks, a professional seeking industry-specific manuals, or someone interested in self-improvement, these digital resources provide an efficient and accessible means of acquiring knowledge. Moreover, PDF books and manuals offer a range of benefits compared to other digital formats. PDF files are designed to retain their formatting regardless of the device used to open them. This ensures that the content appears exactly as intended by the author, with no loss of formatting or missing graphics. Additionally, PDF files can be easily annotated, bookmarked, and searched for specific terms, making them highly practical for studying or referencing. When it comes to accessing Mcculloch Chainsaw Manual Free books and manuals, several platforms offer an extensive collection of resources. One such platform is Project Gutenberg, a nonprofit organization that provides over 60,000 free eBooks. These books are primarily in the public domain, meaning they can be freely distributed and downloaded. Project Gutenberg offers a wide range of classic literature, making it an excellent resource for literature

enthusiasts. Another popular platform for Mcculloch Chainsaw Manual Free books and manuals is Open Library. Open Library is an initiative of the Internet Archive, a non-profit organization dedicated to digitizing cultural artifacts and making them accessible to the public. Open Library hosts millions of books, including both public domain works and contemporary titles. It also allows users to borrow digital copies of certain books for a limited period, similar to a library lending system. Additionally, many universities and educational institutions have their own digital libraries that provide free access to PDF books and manuals. These libraries often offer academic texts, research papers, and technical manuals, making them invaluable resources for students and researchers. Some notable examples include MIT OpenCourseWare, which offers free access to course materials from the Massachusetts Institute of Technology, and the Digital Public Library of America, which provides a vast collection of digitized books and historical documents. In conclusion, Mcculloch Chainsaw Manual Free books and manuals for download have transformed the way we access information. They provide a cost-effective and convenient means of acquiring knowledge, offering the ability to access a vast library of resources at our fingertips. With platforms like Project Gutenberg, Open Library, and various digital libraries offered by educational institutions, we have access to an ever-expanding collection of books and manuals. Whether for educational, professional, or personal purposes, these digital resources serve as valuable tools for continuous learning and self-improvement. So why not take advantage of the vast world of Mcculloch Chainsaw Manual Free books and manuals for download and embark on your journey of knowledge?

### **FAQs About Mcculloch Chainsaw Manual Free Books**

How do I know which eBook platform is the best for me? Finding the best eBook platform depends on your reading preferences and device compatibility. Research different platforms, read user reviews, and explore their features before making a choice. Are free eBooks of good quality? Yes, many reputable platforms offer high-quality free eBooks, including classics and public domain works. However, make sure to verify the source to ensure the eBook credibility. Can I read eBooks without an eReader? Absolutely! Most eBook platforms offer web-based readers or mobile apps that allow you to read eBooks on your computer, tablet, or smartphone. How do I avoid digital eye strain while reading eBooks? To prevent digital eye strain, take regular breaks, adjust the font size and background color, and ensure proper lighting while reading eBooks. What the advantage of interactive eBooks? Interactive eBooks incorporate multimedia elements, quizzes, and activities, enhancing the reader engagement and providing a more immersive learning experience. Mcculloch Chainsaw Manual Free is one of the best book in our library for free trial. We provide copy of Mcculloch Chainsaw Manual Free in digital format, so the resources that you find are reliable. There are also many Ebooks of related with Mcculloch Chainsaw Manual Free. Where to download Mcculloch Chainsaw Manual Free online for free? Are you looking for Mcculloch Chainsaw Manual Free

PDF? This is definitely going to save you time and cash in something you should think about.

### **Find Mcculloch Chainsaw Manual Free :**

[leaving certificate exam papers lcvp past exam papers](#)

**leesboeken top 10 vrouwen**

[legal negotiation nutshell larry teply](#)

[lego star wars characters list](#)

[lehrende im blick christoph br uer](#)

[leboffe microbiology 3rd edition](#)

[legrand 604 774](#)

[lecture before massachusetts teachers association](#)

**lebensraum panzergraben tischkalender 2016 quer**

[leica tcrm 1103 manual](#)

**lee krajewski operations management solution manual**

[legend spirit manual turbo](#)

[learning robotics using python](#)

[leaving north haven the further adventures of a small town pastor](#)

**learning microsoft office 2010 advanced student edition cteschool**

### **Mcculloch Chainsaw Manual Free :**

**microsoft visual c an introduction to object oriented chegg** - Sep 03 2023

web unlike static pdf microsoft visual c an introduction to object oriented programming 7th edition solution manuals or printed answer keys our experts show you how to solve

**programming logic and design 8th edition chapter 1 exercise 4** - Apr 29 2023

web dec 29 2015 this is a basic walkthrough of the solution for chapter 1 exercise 4 of the text programming logic and design 8th edition by joyce farrell it is an extremely close

**joyce farrell profiles facebook** - Feb 13 2022

[java programming 9th edition solutions and answers quizlet](#) - May 31 2023



web with expert solutions for thousands of practice problems you can take the guesswork out of studying and move forward with confidence find step by step solutions and answers to

*microsoft visual c 7th edition textbook solutions bartleby* - Aug 02 2023

web joyce farrell publisher cengage learning isbn 9781337102100 view more textbook editions solutions for microsoft visual c view samples chapter section problem

**chapter 4 solutions programming logic and design chegg** - Mar 29 2023

web step by step solution step 1 of 2 step 2 of 2 back to top corresponding textbook programming logic and design comprehensive 8th edition isbn 13 9781285982809

**joyce e farrell biography stanford university** - May 19 2022

web electrical engineering web page scien stanford edu jfsite print profile email profile view stanford only profile bio teaching academic appointments sr research

**programming logic and design 8th edition chapter 3** - Nov 24 2022

web joyce farrell joyce farrell has authored several popular programming textbooks including books on programming logic and design java c these true false mini

programming logic and design comprehensive 8th edition - Aug 22 2022

web jan 5 2012 joyce farrell cengage learning jan 5 2012 computers 325 pages prepare beginning programmers with the most important principles for developing

programming logic design comprehensive joyce farrell - Jan 27 2023

web joyce farrell cengage learning jan 27 2017 computers 656 pages readers prepare for programming success with the fundamental principles of developing structured

*answered textbook joyce farrell microsoft bartleby* - Dec 26 2022

web the closer the answers are to your desired true love answers the better match the two of you are for each other for example suppose you choose the statement broccoli is

joyce farrell solutions chegg com - Oct 04 2023

web 39 rows 505 problems solved joyce farrell java programming 7th edition 620 problems solved joyce farrell bundle programming logic and design

**an introduction to object oriented programming archive org** - Feb 25 2023

web jun 18 2022 farrell joyce publication date 2016 topics object oriented programming computer science c computer program language visual programming computer

ae java programming cengage asia - Oct 24 2022

web jul 26 2017 joyce farrell cengage learning jul 26 2017 computers 784 pages develop the strong programming skills needed for professional success with farrell s

[mattsblack java programming 8th edition github](#) - Jul 01 2023

web java programs and answers from the book java programming 8th edition by joyce farrell github mattsblack java programming 8th edition java programs and answers from

[programming logic and design introductory joyce farrell](#) - Jul 21 2022

web joyce farrell is the author of many programming books for course technology a part of cengage learning her books are widely used as textbooks in higher education institutions

[joyce farrell wikipedia](#) - Jun 19 2022

web joyce farrell biography publications teaching scien biography joyce graduated from the university of california at san diego in 1976 with a b s in experimental psychology

**is that james joyce joycean style as a punchline** - Mar 17 2022

web view the profiles of people named joyce farrell join facebook to connect with joyce farrell and others you may know facebook gives people the power to

[microsoft visual c an introduction to object oriented](#) - Sep 22 2022

web isbn 9781285776712 joyce farrell sorry we don t have content for this book yet find step by step expert solutions for your textbook or homework problem find step by step

[joyce farrell s profile stanford profiles](#) - Apr 17 2022

web an article from the straight dope s website addresses a reader s question as to whether finnegan s wake was meant purely as a literary practical joke a theory advanced by

**daily oral geography week 26 flashcards quizlet** - Jul 07 2023

web start studying daily oral geography week 26 learn vocabulary terms and more with flashcards games and other study tools

**daily geography week 21 flashcards quizlet** - Jan 01 2023

web what is an iceberg a huge chunk of ice floating in the ocean which nation which was formerly known as east pakistan and whose capital is dhaka is almost completely surrounded by india what is a continental divide where is the continental divide in the united states a high ridge that separates the direction rivers flow rocky mountains

[sampler answer key evan moor](#) - Oct 10 2023

web answer key daily geography practice is based on the eighteen national geography standards and is designed to support any geography and social studies curriculums that you may be using in your classroom 36 weekly sections teacher page an

answer key for the week is included for easy reference the national geography

**daily geography week 35 answers** - Feb 19 2022

web check in the daily geographic practice 6th class teacher edition from evan moor com is an easy to follow printed version that contains 36 weeks of practical daily geographic practice that will have your students excited to map daily geographic practice 4th class paperback june 1 2004 daily geography practice class 6 week 12 key answer

**daily geography week 26 answers the sahara desert** - Apr 04 2023

web daily geography week 26 answers the sahara desert six weekly card lessons introduce basic geography and geography terms skills what a perfect hands on approach to geography learning in addition the lessons are designed to support any geography and social studies curriculum

*daily geography week 26 answer key pdf* - Aug 28 2022

web 4 daily geography week 26 answer key 2023 03 11 necessary to understand their world and how geography affects them and others students will develop their map and spatial skills learn how to answer text and photo dependent questions and study the 5 themes of geography each week covers a particular topic and introduces students to a new

**what are the answers to daily geo week 26 answers** - May 05 2023

web sep 27 2023 26 how many miles from denver co to riverton wy 400 miles taking taking this route take i 25 north from denver to u s 20 26 west to shoshoni at exit 189 in casper wyoming follow u s

**daily geography practice grade 4 teacher s edition e book** - Mar 03 2023

web grade 4 daily geography includes 36 weekly units and each weekly unit includes a teacher page with unit overview and answer key a vocabulary list to highlight key geography terms a map page that emphasizes the geography skills for the week question pages with two geography questions for each day of the week plus a weekly

daily geography week 26 answer key free read - Jun 25 2022

web daily geography week 26 answer key 2018 07 06 6 9 daily geography week 26 answer key what are the answers to studies weekly week 26 answers sep 18 2022 the calendar week 26 in year 2022 from monday 27 06 2022 to sunday 03 07 2022 the calendar week 26 in year 2022 aug 17 2022

**get the free daily geography week 9 answer key form pdfiller** - Feb 02 2023

web fill daily geography week 9 answer key edit online sign fax and printable from pc ipad tablet or mobile with pdfiller instantly try now

daily geography week 26 flashcards quizlet - Sep 09 2023

web daily geography week 26 5 0 1 review flashcards learn test match the needle on a compass always points to what pole click the card to flip north pole click the card to flip 1 8 flashcards learn test match created by legitmacyrich terms in this set

8 the needle on a compass always points to what pole north pole

**daily geo week 26 flashcards quizlet** - Aug 08 2023

web science biology ecology daily geo week 26 5 0 5 reviews what is the arctic tundra click the card to flip a cold dry land region that borders the arctic ocean click the card to flip 1 10 flashcards learn test match created by dbeltz0808 teacher terms in this set 10 what is the arctic tundra

**daily geography week 26 answer key 2023 gestudy byu edu** - Oct 30 2022

web feb 25 2023 daily geography week 26 answer key this is likewise one of the factors by obtaining the soft documents of this daily geography week 26 answer key by online you might not require more era to spend to go to the books start as skillfully as search for them in some cases you likewise attain not discover the proclamation daily geography

*quia daily geography week 26* - Jun 06 2023

web daily geography week 26 this activity was created by a quia web subscriber

**daily geography week 26 answer key pdf free** - Sep 28 2022

web daily geography week 26 answer key 2011 08 08 4 9 daily geography week 26 answer key resources problem of the week university of sep 30 2023 the problem of the week is designed to provide students with an ongoing opportunity to solve mathematical problems each week problems from various areas of mathematics resources problem of the week

**daily geo week 19 flashcards quizlet** - Jul 27 2022

web sep 19 2023 learn test match created by mccalls teacher terms in this set 10 the united states is divided into how many regions are all 50 states represented in these regions 6 yes alaska and hawaii are part of which region why are they part of this region pacific region they border the pacific ocean

**week 26 dg flashcards quizlet** - Nov 30 2022

web week 26 dg created by drew starr terms in this set 8 biome a large area or environment that shares the same general climate of temperature and rainfall different biomes support different types of plants and animals desert a dry region with little or no rainfall dune a mound or ridge of windblown sand ecosystem

**daily geography week 16 flashcards quizlet** - Apr 23 2022

web start studying daily geography week 16 learn vocabulary terms and more with flashcards games and other study tools

**6th grade daily geo week 11 flashcards quizlet** - Mar 23 2022

web expert solutions log in 6th grade daily geo week 11 rivers mississippi ohio and colorado states mississippi ohio colorado and california continents asia africa and north america oceans atlantic pacific and indian click the card to flip spurlock2012 students also viewed daily geography week 12 grade 6 ame182 preview daily geo 12

**cpb us w2 wpmucdn com** - May 25 2022

web cpb us w2 wpmucdn com

[islamic history a very short introduction goodreads](#) - Jan 08 2023

web does history matter this book argues not that history matters but that islamic history does this very short introduction introduces the story of islamic history the

**islamic history a very short introduction ebooks com** - Oct 05 2022

web this very short introduction introduces the story of islamic history the controversies surrounding its study and the significance that it holds for muslims and for non muslims

**islamic history a very short introduction oa** - Apr 30 2022

web opening with a lucid overview of the rise and spread of islam from the seventh to the twenty first century this very short introduction introduces the out of the society an

**islamic history a very short introduction oxford academic** - Jun 13 2023

web the introduction takes a brief look at the geography of islam now and in the past to show how these questions may be answered is islamic history the history of those places

**islamic history a very short introduction very short introductions** - Nov 06 2022

web this very short introduction introduces the story of islamic history the controversies surrounding its study and the significance that it holds for muslims and for non muslims alike

**islamic history a very short introduction oxford academic** - Oct 25 2021

web islamic history a very short introduction very short introductions oxford 2010 online edn oxford academic 24 sept 2013 doi org accessed 11 feb 2023

[islamic history a very short introduction amazon com](#) - Aug 03 2022

web this book argues not that history matters but that islamic history does this very short introduction introduces the story of islamic history the controversies surrounding its

[islamic history a very short introduction very sh copy ol wise edu](#) - Jan 28 2022

web islamic history a very short introduction very sh 1 islamic history a very short introduction very sh this is likewise one of the factors by obtaining the soft documents

[islam a very short introduction 2 e very short introductions](#) - Feb 26 2022

web islam a very short introduction 2 e very short introductions malise ruthven amazon com tr kitap

**islamic history a very short introduction oxford university press** - Sep 04 2022

web provides a chronological survey of the origins and subsequent spread of islam throughout the world demonstrates the cultural and religious diversity of islamic societies explores

**islamic history a very short introduction oxford academic** - Dec 07 2022

web the geographical environment in which islamic history unfolded shaped muslim societies in very particular ways the great arid zone presented muslims with harsh realities that

**islam a very short introduction oxford academic** - Dec 27 2021

web jan 26 2012 islam a very short introduction examines why islam has such major divisions between movements such as the shi ites the sunnis and the wahhabis and

**references and further reading islamic history a very short** - Nov 25 2021

web references and further reading islamic history a very short introduction very short introductions oxford 2010 online edn oxford academic 24 sept 2013

*islamic history a very short introduction oxford academic* - Aug 15 2023

web jan 21 2010 islamic history a very short introduction answers this question by introducing the story of islamic history the controversies surrounding its study and the

**a brief history of islam all parts the religion of islam** - Mar 30 2022

web apr 19 2006 parts of this article a brief history of islam part 1 of 5 the prophet of islam a brief history of islam part 2 of 5 the hijrah a brief history of islam part 3

*islamic history a very short introduction google books* - Apr 11 2023

web jan 21 2010 this book argues not that history matters but that islamic history does this very short introduction introduces the story of islamic history the controversies

**islam a very short introduction ruthven malise free** - Jun 01 2022

web english xiv 177 pages 18 cm islam a very short introduction examines why islam has such major divisions between movements such as the shi ites the sunnis and the

*islamic history a very short introduction very short* - Jul 02 2022

web jan 21 2010 this very short introduction introduces the story of islamic history the controversies surrounding its study and the significance that it holds for muslims and

**copyright page islamic history a very short introduction** - Sep 23 2021

web great clarendon street oxford ox2 6dpoxford university press is a department of the university of oxford it furthers the university s objective of excellence i

**islamic history a very short introduction silverstein adam j** - Jul 14 2023

web language english xviii 157 pages 18 cm opening with a lucid overview of the rise and spread of islam from the seventh to the twenty first century this very short

**islamic history a very short introduction paperback adam j** - Feb 09 2023

web 21 january 2010 isbn 9780199545728 176 pages paperback 174x111mm in stock very short introductions price 8 99  
how did islam arise from the obscurity of seventh

**islamic history a very short introduction google books** - Mar 10 2023

web jan 21 2010 this book argues not that history matters but that islamic history does this very short introduction  
introduces the story of islamic history the controversies

**islamic history a very short introduction amazon com** - May 12 2023

web feb 1 2010 opening with a lucid overview of the rise and spread of islam from the seventh to the twenty first century  
this very short introduction introduces the story of